

# HITACHI P1 BASIC INSTRUCTION MANUAL

## DETROIT HOIST PROGRAM V27-V28

Detroit Hoist & Crane LLC, Co.  
6650 Sterling Drive North, Sterling Height Michigan 48312  
+1 586-268-2600

Manual Revision V1.4

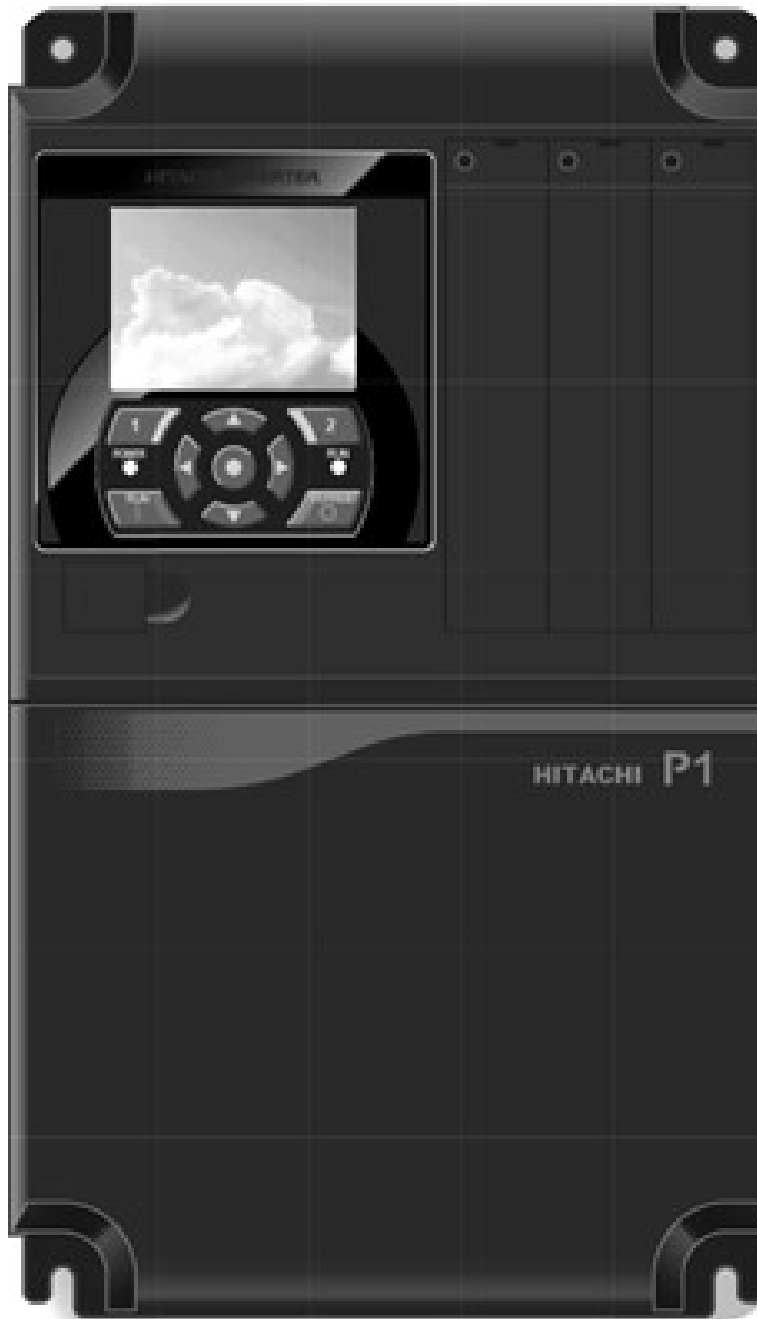

Author: Matthew Kinney

# Stop Read First!

**Important!** – This manual was created Detroit hoist program version 27 or 28. Please verify the program number before using this manual by navigating to VFD parameter db-02. To navigate to db-02 and check your VFD's program number follow the steps chart below.

Step	Instruction
1	Power up the VFD.
2	Press the #1 button on the display one time and the screen will change to a menu listing with scroll mode at the top of the screen.
3	With "SCROLL MODE" highlighted press the center dot button on the display to enter the "SCROLL MENU"
4	Using the down arrow button highlight "d:Monitor" and press the center dot button to enter the "MONITOR" listing.
5	Press the #2 button on the display one time to move from the dA group to the db group. You should now see db-02 parameter shown in the middle of the screen. The program number will be displayed in db-02, verify that it is 27 or 28.
6	To return to the main screen press the #1 button three times or you can simply cycle power.

## TABLE OF CONTENTS

BASIC SPECIFICATIONS .....	6
POWER CIRCUIT WIRING.....	7
CONTROL CIRCUIT WIRING .....	8
CONFIGURING SPEED CONTROL METHOD .....	9
CONFIGURING SPEEDS / FREQUENCIES .....	10
MULTI-STEP SPEED COMMAND .....	11
ACCELERATION / DECELERATION TIMES.....	12
ALTERNATE ACCELERATION / DECELERATION TIMES .....	12
MICRO-SPEED FUNCTION.....	13
LIMIT TO 1 <sup>ST</sup> SPEED FUNCTION .....	13
AUTO-SPEED 90HZ FUNCTION LEGACY.....	14
AUTOMATIC ADAPTIVE AUTO-SPEED FUNCTION (AAAS) .....	15
125% FIELD LOAD TESTING / OVER-WEIGHT BYPASS .....	16
HOIST OVER-WEIGHT FUNCTION .....	17
HOIST OVER-WEIGHT PARAMETERS .....	17
SETTING HOIST OVER-WEIGHT .....	18
CONFIGURING AN OUTPUT FOR FAULT SIGNAL .....	19
RESET FAULT USING INPUT .....	19
OUTPUT 0-10V / 4-20mA .....	19
ELECTRONIC MOTOR THERMAL PROTECTION .....	20
MOTOR THERMAL PROTECTION USING THERMISTOR .....	20
SHOCK-LOAD PREVENTION / DETECTION (CLV).....	21
MOTOR BRAKE PARAMETERS .....	22
ENCODER-BASED OPERATIONAL HOOK BLOCK LIMITS (CLV) .....	23
ENCODER-BASED LIMITS PARAMETERS (CLV).....	23
SETTING ENCODER-BASED LIMITS (CLV) .....	24
OUTPUT SIGNAL FOR ENCODER LIMITS (CLV).....	25
ENCODER PARAMETERS (CLV) .....	26
LOAD FLOAT (CLV).....	27
MOTOR TORQUE PROVING (CLV) .....	27
MOTOR BRAKE SLIP DETECTION (CLV).....	28
TANDEM HOIST EZCOM (SPEED / COMMAND / STATUS SYNCING) .....	29
EZCOM SETUP GUIDE .....	30
EZCOM PARAMETERS.....	30
EZCOM CIRCUIT WIRING .....	31

HOOK BLOCK SYNCING / PULSE TRAIN POSITION COMMAND (CLV) .....	32
PULSE TRAIN POSITION COMMAND PARAMETERS (CLV).....	32
TROUBLESHOOTING PULSE TRAIN POSITION COMMAND (CLV) .....	32
PULSE TRAIN POSITION COMMAND WIRING EXAMPLE (CLV).....	33
VFD CONTROL MODES .....	34
MANUAL TORQUE BOOST / AUTOMATIC TORQUE BOOST PARAMETERS .....	34
AUTO-TUNING.....	35
MOTOR CONSTANTS .....	35
SPEED DEVIATION (CLV).....	36
DYNAMIC BRAKING .....	37
OVER-SPEED (CLV).....	38
CARRIER FREQUENCY .....	38
GROUND FAULT PROTECTION .....	38
INPUT PHASE LOSS PROTECTION .....	39
OUTPUT PHASE LOSS PROTECTION .....	39
INPUT POWER SUPPLY OVER-VOLTAGE PROTECTION.....	40
OVER-TORQUE DETECTION.....	40
TORQUE LIMIT.....	40
MONITOR DIGITAL INPUTS .....	41
MONITOR PARAMETERS .....	42
TROUBLESHOOTING E50 FAULT.....	43
TROUBLESHOOTING E51 FAULT.....	44
TROUBLESHOOTING E52 FAULT.....	45
TROUBLESHOOTING E53 FAULT.....	46
TROUBLESHOOTING E054 FAULT.....	47
TROUBLESHOOTING E001 / E005 / E039 FAULTS .....	48
TROUBLESHOOTING E006 FAULT.....	48
TROUBLESHOOTING E007 FAULT.....	49
TROUBLESHOOTING E014 / E030 FAULT .....	49
TROUBLESHOOTING E016 FAULT.....	50
TROUBLESHOOTING BLANK SCREEN / DISPLAY .....	51
TEMPORARILY SWITCHING FROM CLOSED LOOP TO OPEN LOOP .....	51
FAULT / ERROR CODES DESCRIPTION .....	52
VIEW FAULT HISTORY.....	54
CLEARING FAULT HISTORY .....	55
USING THE KEYPAD .....	56



## BASIC SPECIFICATIONS

For specifications that are not listed please contact Detroit Hoist for further information.

- Input power 3-phase 50/60hz (recommended).
- Single phase applications must derate VFD to 70% and may require a larger VFD to supply the required motor current. Please contact Detroit Hoist for further information on single phase applications.
- 380-480Vac (400v class models P1-\*\*\*\*\*-H).
- 208-240Vac (200v class models P1-\*\*\*\*\*-L).
- Digital I/O's are 24vdc (27vdc max).
- Voltage fluctuation must be -15% to +10% or less.
- Voltage imbalance must be  $\pm 3\%$  or less.
- Frequency variation must be  $\pm 4\%$  or less.
- Total harmonic distortion (THD) of voltage must be  $\pm 10\%$  or less.
- Ambient temperature -10 to 50°C | 14 to 122 °f.
- In case of utilization at an altitude of 1000m or more, consider that the atmospheric pressure is reduced by 1% for every 100m up. Apply 1% derating from the rated current by increasing every 100m and conduct an evaluation test.
- IP20 – UL Open Type.
- Overload Current Rating 150% 60sec / 200% 3sec.
- All Digital I/O is 24vdc.
- Suitable for use on a circuit capable of delivering not more than 5,000 rms symmetrical amperes.
- Integral solid state short circuit protection does not provide branch circuit protection. Branch circuit protection must be provided in accordance with the National Electrical Code and any additional local codes.
- Pollution degree 2 environment and Overvoltage category III.
- Built-in dynamic braking chopper circuit up to 37kw models.
- Built-in EMC filter. The built-in EMC filter must be activated.

## POWER CIRCUIT WIRING



### • Risk of electric shock!

- Before inspecting the inverter, be sure to turn off the power supply and wait for more than 10 or 15 minutes depending on the inverter model\*1. (Before inspection, confirm that the Charge lamp on the inverter is off and the DC bus voltage between terminals P and N is 45 V or less.)



### • Risk of electric shock!

- Before inspecting the inverter, be sure to turn off the power supply and wait for more than 10 or 15 minutes depending on the inverter model\*1. (Before inspection, confirm that the Charge lamp on the inverter is off and the DC bus voltage between terminals P and N is 45 V or less.)

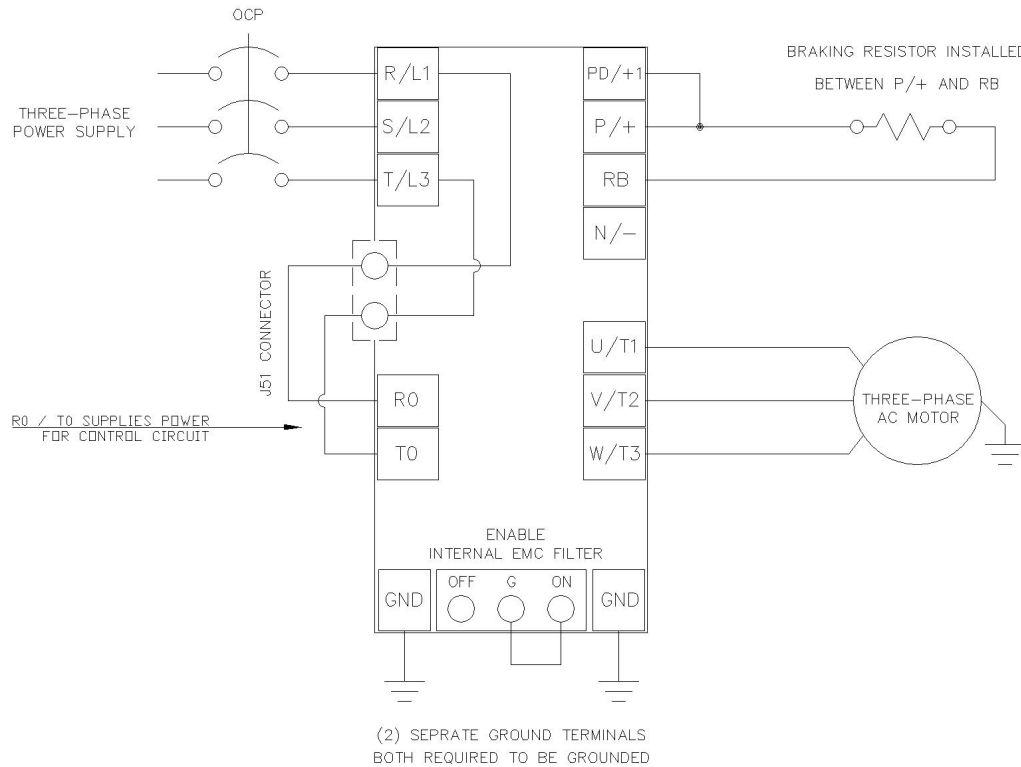

Terminal Symbol	Basic Description	Extended Description
R, S, T (L1, L2, L3)	Main power input (3-ph 50/60hz)	Connect to the AC power supply. Leave these terminals unconnected when using a front end regenerative converter.
U, V, W (T1, T2, T3)	Inverter motor output	Connect three-phase motor or load reactor.
PD, P (+1, +)	DC link choke connection terminal	Remove the PD-P jumper from terminals and connect the optional DC link choke for power factor improvement.
P, N (+, -)	DC bus positive and negative terminals.	Connection of a back end regenerative converter or external braking unit.
P, RB (+, RB)	Dynamic braking chopper circuit	Connect braking resistor.
R0, T0	Control circuit power supply connection	Uses L1 & L3 for power for control circuit power supply. Can also be reconfigured for to use DC bus by moving the J51 jumper and connecting R0 to terminal P/+ and T0 to terminal N/-.

## CONTROL CIRCUIT WIRING

Below is a basic example of the control circuit for the Hitachi P1 with the DH firmware and may differ from the actual configuration please reference the provided electrical drawing. Please consult Detroit Hoist if you plan to make changes to the control circuit for specific functions to ensure compatibility with the DH firmware. Please note that not all functions provided by standard Hitachi manual are compatible with the DH firmware and the use of them may cause the VFD to become unusable or unsafe.

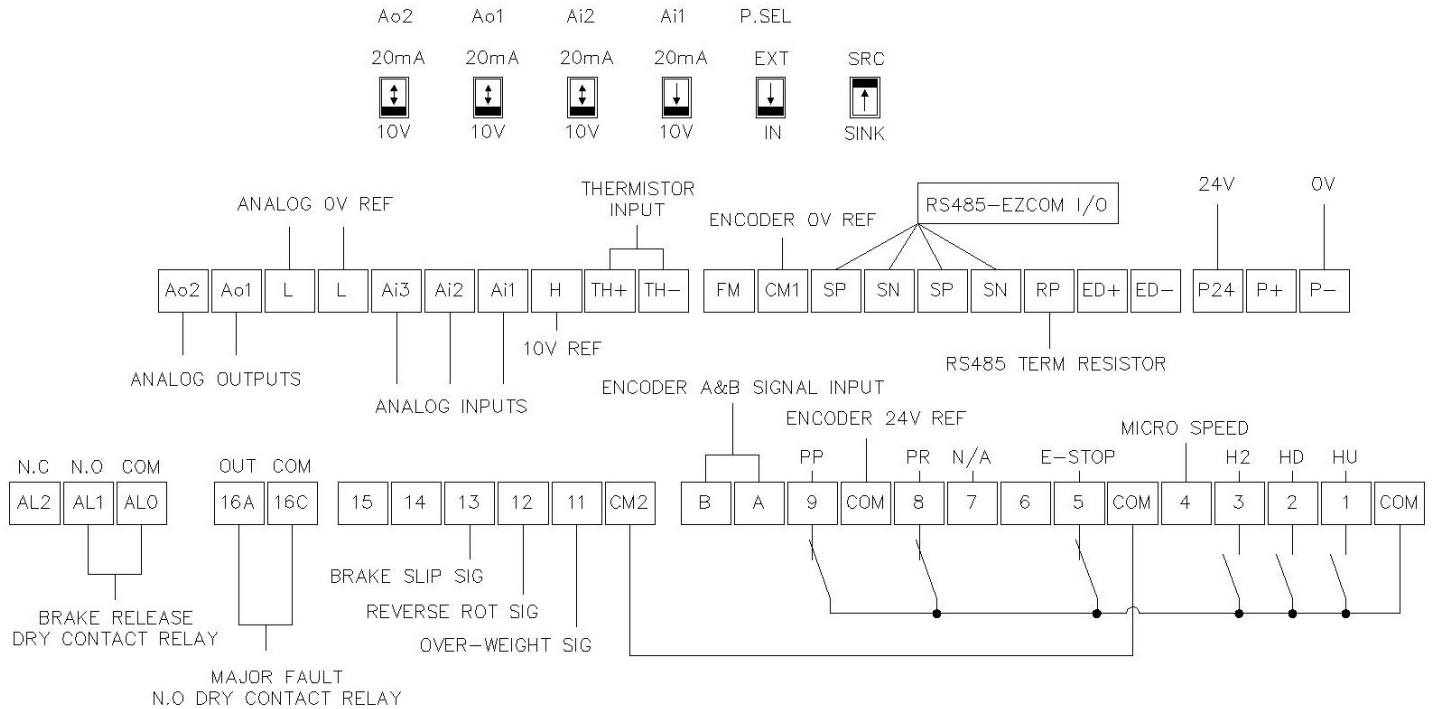

Terminal Symbol	Description
COM	Internal 24V power supply COM
1 - 9 * 7 not configurable	24v digital inputs for command functions. 5.6mA Terminal 4, 6, 8, 9 can be configured for allowed functions.
A, B	24v Encoder input for control main body. CA-90 = 02 speed feedback
CM2	COM for 24v digital outputs 11 - 15
11 - 15	24v digital outputs. 60mA max
16A - 16C	16 relay SPST   250vac 5A(resistive) \ 250vac 1A(inductive)
ALO (COM), AL1 (N.O), AL2 (N.C) * not configurable	Brake release relay SPDT   250vac 5A(resistive) \ 250vac 1A(inductive)
Ao2, Ao1	Analog outputs can be configured for 0-10v or 4-20mA using the dip switches above.
L	0v / ground reference for all analog I/O's
Ai1, Ai2, Ai3	Analog inputs, only Ai1 and Ai2 can be configured for 0-10v or 4-20mA. Ai3 is 0-10v only. Reference the dip switches above the analog terminals for switching between 0-10v and 4-20mA
H	Internal 10v reference.
TH+, TH-	Motor thermistor input. Allowable rated power: 100mW or more Impedance at abnormal temperature: 3kΩ. DC 0 ~ 5V input circuit. NTC type recommended in order to use the monitor function for temperature read out.
FM	FM output is selectable from PWM output with a fixed cycle of 6.4ms or pulse output with a variable cycle. CM1 is COM for FM.
CM1	0v ground reference for 24v control circuit



<b>SN, SP</b>	RS485 / Ezcom communication terminals. Used for Modbus or Ezcom communication. Shielded twisted wire required and grounding of shield.
<b>RP</b>	RS485 / Ezcom communication termination resistor. Used on the last VFD of the communication circuit by installing jumper between RP and SN.
<b>P24</b>	24v power supply
<b>P+, P-</b>	Can be used for adding external 24v power supply and switching the P.SEL dip switch to EXT.

## CONFIGURING SPEED CONTROL METHOD

Detroit Hoist VFD controls come factory pre-configured for 2-Step speed control unless otherwise specified during the ordering process.

Use the chart below to configure the speed control method that is required.

If additional inputs are required for the desired speed control method, you will need to add the appropriate circuit if one is not present on the panel. Please consult Detroit Hoist for a wiring diagram to modify the control circuit and provide you with the required components.

Speed Control Method	Parameters	Values
<b>2-Step</b> (factory default)	UE-18	0
<b>2-Step Infinitely Variable</b>	UE-18	1
<b>3-Step</b>	UE-18	2
	CA-06	91
<b>3-Step Infinitely Variable</b> Note – Digital Input 6 will be Freq-Hold	UE-18	3
	CA-06	91
<b>0-10V     4-20mA</b>	UE-18	4 (when using Ai1) 5 (when using Ai2)
<b>4 – 16-Step</b>	See Multi-Step Speed Command.	

## CONFIGURING SPEEDS / FREQUENCIES

Speed / frequency values are stored as whole numbers (*example is 15.25 Hz = 1525*).

Use the chart below to configure the speeds / frequencies for the configured speed control method.

If operating at frequencies below or at 5hz for an extended amount of time an external motor cooling device may be required to prevent motor overheating.

Speed Control Method	Speeds	Speed Parameters	Example Values
<b>2-Step</b> (Factory default)	1 <sup>st</sup> speed / low speed	UE-11	1000 (10.00 Hz)
	2 <sup>nd</sup> speed / high speed	UE-12	6000 (60.00 Hz)
<b>2-Step Infinitely Variable</b>	1 <sup>st</sup> speed / low speed	UE-11	1000 (10.00 Hz)
	2 <sup>nd</sup> speed / high speed	UE-12	6000 (60.00 Hz)
<b>3-Step</b>	1 <sup>st</sup> speed / low speed	UE-11	1000 (10.00 Hz)
	2 <sup>nd</sup> speed	UE-12	3500 (35.00 Hz)
	3 <sup>rd</sup> speed / high speed	UE-13	6000 (60.00 Hz)
<b>3-Step Infinitely Variable</b>	1 <sup>st</sup> speed / low speed	UE-11	1000 (10.00 Hz)
	n/a	n/a	n/a
	2 <sup>nd</sup> speed / high speed	UE-12 UE-13	6000 (60.00 Hz)
<b>0-10V     4-20mA</b>	1 <sup>st</sup> speed / low speed	UE-11	1000 (10.00 Hz)
	2 <sup>nd</sup> speed / high speed	UE-12	6000 (60.00 Hz)
<b>Max Auto-Speed Frequency</b>	Auto-Speed	UE-14	9000 (90.00 Hz)
<b>4 – 16-Step</b>	See Multi-Step Speed Command.		

## MULTI-STEP SPEED COMMAND

Multi-Step speed command can be configured up to 16 speeds. Only use multi-step speed command when speed control greater than 3-steps is required. In the multi-step speed command, 4 inputs as a binary combination of 0 (OFF) and 1 (ON) will determine the command frequency, reference the chart below for configuring the steps and speeds. Use the chart below to configure the use of the multi-step speed command.

NOTE – The multi-step speed command steps outside of the internal program to determine the speeds during normal operation. Please make sure that Ab110 & UE-11 match for the low frequency value. Also make sure to set UE-12 to match the high-speed frequency determined by the multi-speed binary operation.

Speed Control Method	Parameters	Values
Multi-Step Speed Command	UE-18	6
Input Speed Source	AA101	7 = Keypad
Multi-Step Digital Inputs	Digital Input 3   CA-03	03 = CF1
	Digital Input 4   CA-04	04 = CF2
	Digital Input 6   CA-06	05 = CF3
	Digital Input 8   CA-08	06 = CF4
Set Encoder Limits to Parameters	UE-33	2

Muti-Step Speed	CF4	CF3	CF2	CF1	Frequency Parameter	NOTE
1 <sup>st</sup> speed	OFF	OFF	OFF	OFF	Ab110	Set UE-11 to match Ab110
2 <sup>nd</sup> speed	OFF	OFF	OFF	ON	Ab-11	Set UE-12 to match the highest frequency set in the multi-step
3 <sup>rd</sup> speed	OFF	OFF	ON	OFF	Ab-12	
4 <sup>th</sup> speed	OFF	OFF	ON	ON	Ab-13	
5 <sup>th</sup> speed	OFF	ON	OFF	OFF	Ab-14	
6 <sup>th</sup> speed	OFF	ON	OFF	ON	Ab-15	
7 <sup>th</sup> speed	OFF	ON	ON	OFF	Ab-16	
8 <sup>th</sup> speed	OFF	ON	ON	ON	Ab-17	
9 <sup>th</sup> speed	ON	OFF	OFF	OFF	Ab-18	
10 <sup>th</sup> speed	ON	OFF	OFF	ON	Ab-19	
11 <sup>th</sup> speed	ON	OFF	ON	OFF	Ab-20	
12 <sup>th</sup> speed	ON	OFF	ON	ON	Ab-21	
13 <sup>th</sup> speed	ON	ON	OFF	OFF	Ab-22	
14 <sup>th</sup> speed	ON	ON	OFF	ON	Ab-23	
15 <sup>th</sup> speed	ON	ON	ON	OFF	Ab-24	
16 <sup>th</sup> speed	ON	ON	ON	ON	Ab-25	

## ACCELERATION / DECELERATION TIMES

When adjusting the deceleration times be sure to check the hook block limit for over travel. If over travel occurs either lower the deceleration time or adjust the limit zones.

Changing the acceleration time to a shorter time can cause a E01 over-current or E05 over-load fault /trip, if this occurs due to a short acceleration time increase the acceleration time and test again.

Changing the deceleration time to a shorter time can cause a E07 over-voltage fault/trip, if this occurs due to a short deceleration time increase the deceleration time and test again.

Use the chart below to configure the standard acceleration and deceleration times.

Function	Parameters	Example Value
Acceleration Time	AC120	2.50 seconds
Deceleration Time	AC122	1.00 seconds
Acceleration Curve	AC-03	00 = liner-curve
		01 = S-curve (default)
		02 = U-curve
		03 = Reverse U-curve
Deceleration Curve	AC-04	00 = liner-curve
		01 = S-curve (default)
		02 = U-curve
		03 = Reverse U-curve

## ALTERNATE ACCELERATION / DECELERATION TIMES

The alternate acceleration and deceleration function can be used to switch from the standard acceleration and deceleration times to an alternate acceleration and deceleration time based on a digital input, frequency break point, or reversal of direction command (aka reverse plugging). If you plan to use switch by input [2CH] you will need to configure an available digital input function for 31:[2CH] (example CA-06 = 31) and add the 24v circuit for that input.

Use the chart below to configure the standard acceleration and deceleration times.

Function	Parameters	Example Value
ALT Acceleration Time	AC124	2.50 seconds
ALT Deceleration Time	AC126	1.00 seconds
Method to switch to ALT Accel / Decel	AC115	00 = Switching by input [2CH] (Configure available digital input function to 31: 2CH)
		01 = Switching by frequency break point
		02 = Switching by direction reversal
Accel to ALT Accel break point	AC116	15.00 Hz
Decel to ALT Decel break point	AC117	15.00 Hz

## MICRO-SPEED FUNCTION

Micro-speed is designed to temporarily restrict the speed of the hoist to a lower speed and to prevent high speed operations until the function is released. The micro-speed function can be configured two ways.

**2-STEP MAINTAINED MODE**– This mode will switch to a 2-Step maintained speed set. This is helpful where the micro-speeds need to be specific. This mode can also be used to provide a single speed by setting the low and high micro speed values the same value. To use this mode UE-16 must have a value of 0.

**PERCENTAGE MODE**– This mode will take the value from UE-16 as a percentage of the standard speed set. Setting UE-16 to a value of 30 will provide a speed that is 30% of the standard speed sets for the configured speed control method.

In the chart below the digital input 4 is configured from the factory for micro-speed.

Function	Parameters	Value
Digital Input 4 Micro-Speed Activation Input	CA-04	89:MI4
Micro-Speed Low-Speed	UE-10	500 (5.00 Hz)
Micro-Speed High-Speed	UE-15	1000 (10.00 Hz)
Micro-Speed Mode	UE-16	Value = 0 ( <i>2-STEP MAINTAINED MODE</i> )
		Value > 0 ( <i>PERCENTAGE MODE</i> )

## LIMIT TO 1<sup>ST</sup> SPEED FUNCTION

For applications where it is required to limit the VFD to 1<sup>st</sup> speed frequency you can configure an available digital input for that function. This is typically used for travel limits or when approaching an upper / lower hook limit. The parameter chart below references setting digital input 6 but any available inputs other than input 7 can be used.

Function	Parameter	Value
Digital Input 6 Function	CA-06	96:MI11
Digital Input 6 Contact Status	CA-26	00 = N.O
		01 = N.C

## AUTO-SPEED 90HZ FUNCTION LEGACY

The auto-speed function will allow the VFD to increase the high speed to 90Hz when there is an empty hook or a light load. You can set this function for automatic or for input activation. The auto-speed function is not available when using 0-10V/4-20mA speed control methods, when micro-speed is active, and or when in tandem mode.

HOW IT WORKS – When the hoist is commanded in the forward/up direction and the frequency reaches the set high speed frequency, the VFD will check to see if the load monitor value is less than the auto-speed activation value and allow the frequency to increase to the auto-speed frequency.

NOTE – While operating in control modes (AA121) sensorless vector control (08), zero speed area sensorless vector control (09), or vector control with encoder (10) the Auto-Speed Activation Value will be based on torque. While operating in any other modes the Auto-Speed Activation Value will be based on the VFD’s output current FLA ratio.

Use the charts below to properly configure the auto-speed function. In the chart below the digital input 6 is shown as the auto-speed input activation.

Function	Parameter	Example Value
Auto-Speed Activation Value	UE-21	500 = 50% VFD’s output current.
Auto-Speed Activation Method	UE-22	0 = Automatic
		1 = With Input Activation (Configure available digital input function to 92: MI7)
Auto-Speed Max Frequency	UE-14	9000 (90.00 Hz)
Digital input 6 Auto-Speed Activation Input	CA-06	92:MI7

Step	Instruction
1	Attached 30% rated load to the hook block and lift the load just off the ground. <i>*NOTE – 30% should be the max load for 90 Hz &amp; 60% should be the max load for 75 Hz</i>
2	Navigate to VFD parameter db-14. This will display the load value that will be used to set the auto-speed activation level.
3	Using the pushbutton or radio, command the hoist in the up/forward direction with high speed and record the value of VFD parameter db-14 while the load is operating at the high-speed frequency.
4	Navigate to VFD parameter UE-21 and set the value to the value recorded from db-14 + 3%. (Example db-14 = 37, set UE-21 = 40)
5	Verify the auto-speed function works by lifting the same load at high speed. If the auto-speed function is configured for automatic then you should see the speed increase to 90hz, if you are using the input activation function then make sure the input is active and you should see the speed increase to 90hz

## AUTOMATIC ADAPTIVE AUTO-SPEED FUNCTION (AAAS)

This additional function is only available with V28 program.

The automatic adaptive auto-speed (AAAS) function will automatically increase the high speed to the fastest possible while keeping the output motor current 10% below the overload / over-weight current settings to prevent trips and false over-weight detections. None of the auto-speed functions are available when using 0-10V/4-20mA speed control methods, when micro-speed is active, and or when in tandem mode.

HOW IT WORKS – AAAS works by monitoring the motor current against the high-speed overload value and will continuously increment the output speed until the motor current is in the to 90% - 92% zone of the high-speed overload value.

The speed that is achieved during a lift will be logged and will be the maximum speed that can be achieved in the lowering direction.

If loading changes during the lift the VFD will starting de-incrementing the speed back to the standard high-speed until the motor current becomes in the 90% - 92% zone of the high-speed overload value or until the speed reaches the standard high-speed.

Use the charts below to properly configure the auto-speed function. In the chart below the digital input 6 is shown as the auto-speed input activation, this is not required unless you want an input to allow the function to activate.

Function	Parameter	Example Value
Auto-Speed Activation Value	UE-21	0
Auto-Speed Activation Method	UE-22	2 = Automatic Adaptive
		3 = Automatic Adaptive with Input Activation (Configure available digital input function to 92: MI7)
Digital input 6 Auto-Speed Activation Input	CA-06	92:MI7
Auto-Speed Max Frequency	UE-14	9000 (90.00 Hz) Max

## 125% FIELD LOAD TESTING / OVER-WEIGHT BYPASS

Each hoist is factory load tested prior to shipment. If a field load test is required, you will need to bypass the over-weight signal.

To bypass the over-weight signal, locate the bypass terminal knife disconnect it should be labeled “BPS” (use images below as reference) and pull the yellow/orange tab to open.

**IMPORTANT** - Be sure to close the over-weight bypass terminal knife disconnect “BPS” after the load test is complete, failure to do so may result in damage to the hoist in the case of an overload.

NOTE – Detroit Hoist recommends that 125% load tests should only be conducted by operating the hoist in low speed when the 125% load is suspended or the VFD may fault.



*Over-Weight Bypass Knife Disconnect*



## HOIST OVER-WEIGHT FUNCTION

The VFD is setup to use the output current to the motor as the over-weight function. The VFD uses (2) over-weight current parameters. Over-weight (1) is when operating less than or equal to the low-speed frequency and over-weight (2) is when operating above low-speed frequency. The VFD automatically switches between over-weight (1) and over-weight (2) based on the frequency. Having (2) over-weights greatly increases over-weight accuracy and decreases the likelihood of a false over-weight condition.

The VFD has an alternative over-weight current parameter source that can be configured. This is normally used in applications where the hoist over-weight needs to be limited to a lower value in certain parts of a building or runway. The alternative over-weight uses (2) over-weight current parameters in the same configuration as the standard over-weight function. To use the alternative over-weight, configure the parameters in the chart below and modify the over-weight circuit to switch the source of the signal to the 24v DPDT relay between digital output 11 and digital output 14.

The VFD has (3) configurations for the over-weight signal, external momentary, external maintained, Internal.

**External momentary** - will output a signal when the condition is met but will not maintain the output after the condition is no longer met.

**External maintained** - will output a signal when the condition is met and maintain the signal until the reset condition is met or power is cycled.

**Internal** - does not require any external circuits to function. Internal works the same way as the external maintained but will internally prevent the hoist up function until the reset condition is met or power is cycled.

**NOTE** – *Internal is only latched to the STANDARD OVER-WEIGHT function.*

HOW IT WORKS – When the output current to the motor exceeds the value in the conditional over-weight current parameter for an amount of time that exceeds the detection delay time, the conditional digital output will turn on and activate a 24v relay to interrupt the hoist E-Stop circuit. The signal is turn off once the hoist has lowered for 2.0 seconds.

## HOIST OVER-WEIGHT PARAMETERS

Function	Parameters	Example Value
Over-Weight Signal Output Type	UE-54	0 = External Momentary
		1 = External Maintained
		2 = Internal
Over-Weight Detection Delay Time	UE-55	150 = (1.5 seconds)
Over-Weight Reset Time	UE-56	200 = (2.0 seconds)
<b>Standard Over-Weight</b>		
Standard Over-Weight (1) Value *Low Speed	CE106	14.0 Amps
Standard Over-Weight (2) Value *High Speed	CE107	15.0 Amps
Digital Output 11 Function	CC-01	69:MO1
Digital Output 11 Status	CC-11	00: N.O
<b>Alternative Over-Weight</b>		
Alternative Over-Weight (1) Value *Low Speed	CE102	10.0 Amps
Alternative Over-Weight (2) Value *High Speed	CE103	11.0 Amps
Digital Output 14 Function	CC-04	73:MO5
Digital Output 14 Status	CC-14	00: N.O

## SETTING HOIST OVER-WEIGHT

Each hoist's over-weight settings will be set at the factory prior to shipment. In some cases, field adjustments may be required. Use the step chart below to set the hoist's over-weight settings.

NOTE – If you are setting the alternative over-weight parameters use steps 6A and 7A

Step	Instruction
1	Locate the terminal knife disconnect labeled "BPS" and pull the top of the yellow/orange tab outwards, this will bypass the over-weight circuit.
2	Attach the 100% rated load to the hook block.
3	On the hoist VFD's display there will be an output current monitor. If the display does not show an output current monitor go to parameter dA-02 to monitor the output current to the motor.
4	Proceed to lift the 100% rated load off the ground in low speed. Monitor the output current to the motor and write it down. Be sure to wait for the output current to normalize
5	Proceed to lift the 100% rated load off the ground in high speed. Monitor the output current to the motor and write it down. Be sure to wait for the output current to normalize.
6	Take the value from step 4 and multiply it by 1.05 and set <b>STANDARD</b> over-weight (1) parameter CE106 to that value.
6A	Take the value from step 4 and multiply it by 1.05 and set <b>ALTERNATIVE</b> over-weight (1) parameter CE102 to that value.
7	Take the value from step 5 and multiply it by 1.05 and set <b>STANDARD</b> over-weight (2) parameter CE107 to that value.
7A	Take the value from step 5 and multiply it by 1.05 and set <b>ALTERNATIVE</b> over-weight (2) parameter CE103 to that value.
8	Locate the terminal knife disconnect labeled "BPS" and close the tab.
9	Operate the hoist in low and high speed with the 100% rated load. If the over-weight circuit trips in low speed, then increase the value of over-weight (1) parameter until it no longer trips. If the over-weight circuit trips in high speed, then increase the value of over-weight (2) parameter until it no longer trips.

## CONFIGURING AN OUTPUT FOR FAULT SIGNAL

The VFD will come from Detroit Hoist with output 16 (dry contact) already configured for fault alarm signal. If you need to switch the fault alarm signal to a different output, use the chart below.

Function	Parameters	Value
Fault Alarm Signal	CC-01 thru CC-05 (24vdc digital i/o)	017 = AL (Alarm)
	CC-06 (16 relay dry contact)	

## RESET FAULT USING INPUT

Resetting a fault remotely using an input to the VFD can be done by configuring one of the available digital inputs for reset. Use the chart below.

Function	Parameters	Value
Fault reset	CA-04, CA-06	028 = RS
	CA-08, CA-09 (when using encoder limits with parameters UE-33 = 2)	

## OUTPUT 0-10V / 4-20mA

The output analog can be configured for multiple functions. Listed below are the most common functions used for hoist and crane applications. If the function is not present, please contact Detroit Hoist for further assistance.

Function	Parameters	Value	Description
Ao1 – Analog output 1 function	Cd-04	dA-01 = Output Frequency dA-02 = Output Current dA-17 = Output Torque	
Ao2 – Analog output 2 function	Cd-05		
Analog monitor adjust mode	Cd-10	0 = disabled 1 = enabled	1 = Outputs to terminals output levels in the adjustment mode.
Ao1 filter time constant	Cd-21	1 – 500 ms	Filters and outputs the selected data.
Ao1 data type	Cd-22	00 = Absolute data	Outputs the absolute value of data
		01 = Signed data	Outputs data with a symbol as is.
Ao1 monitor bias adjustment	Cd-23	-100.0 – 100.0%	Biases data to adjust Point 0 of data.
Ao1 monitor gain adjustment	Cd-24	-1000.0 – 1000.0%	Apply a gain to data to adjust an inclination in data.
Ao1 output level setting at Ao1 monitor adjust mode	Cd-25	-100.0 – 100.0%	Sets output in the adjustment mode. It selects the maximum output (at 100.0%), the minimum output (at 0.0%) ([Cd-22]=00), or the minimum output (at -100.0%) ([Cd-22]=01).
Ao2 filter time constant	Cd-31	1 – 500 ms	Filters and outputs the selected data.
Ao2 data type	Cd-32	00 = Absolute data	Outputs the absolute value of data
		01 = Signed data	Outputs data with a symbol as is.
Ao2 monitor bias adjustment	Cd-33	-100.0 – 100.0%	Biases data to adjust Point 0 of data.
Ao2 monitor gain adjustment	Cd-34	-1000.0 – 1000.0%	Apply a gain to data to adjust an inclination in data.
Ao2 output level setting at Ao2 monitor adjust mode	Cd-35	-100.0 – 100.0%	Sets output in the adjustment mode. It selects the maximum output (at 100.0%), the minimum output (at 0.0%) ([Cd-32]=00), or the minimum output (at -100.0%) ([Cd-32]=01).

## ELECTRONIC MOTOR THERMAL PROTECTION

The VFD has a built-in electronic motor thermal protection function and is configured for constant torque loading. When the output current exceeds the value in bC110 for a calculated time based on frequency, time and a reduction ratio. The electronic thermal protection function also has the ability to save the current data and calculate it based on output current and time.

Function	Parameters	Value
Electronic thermal level	bC110	Motor FLA * 1.25
Electronic thermal subtraction function	bC112	0 = disabled
		1 = enabled
Electronic thermal subtraction time	bC113	600 sec
Electronic thermal counter memory function	bC-14	0 = disabled
		1 = enabled

## MOTOR THERMAL PROTECTION USING THERMISTOR

The temperature protection of an external device can be made by connecting a thermistor installed in the motor or other external device to the inverter and setting the function of the thermistor. The external thermistor should be wired between the control terminals TH+ and TH-. Set the thermistor selection [Cb-40] and the resistance level to cause an error [bb-70] in accordance with the thermistor's specifications. When [Cb-40] is set to 02, [dA-38] motor temperature monitor indicates the detected temperature of the motor.

[E035] thermistor error occurs when the thermistor resistance reaches the thermistor error level [bb-70] depending on the motor temperature.

To use this function, the wiring distance between the motor and the inverter should be 20 m or shorter. Since the current flowing in the thermistor is very weak, a measure such as wiring separation should be taken to prevent noise from the motor current.

When [Cb-40] is set to a value other than 02 NTC negative temperature coefficient resistor, [dA-38] motor temperature monitor indicates 0 °C.

Function	Parameters	Value
Thermistor error level	bb-70	0 ~ 10000 ohms (10k )
Thermistor selection	Cb-40	0 = disabled
		1 = PTC
		2 = NTC
Thermistor gain adjustment	Cb-40	0.0 ~ 1000
Motor temperature monitor	dA-38	-20.0 ~ 200.0 °C

## SHOCK-LOAD PREVENTION / DETECTION (CLV)

Shock-Load prevention / detection is only valid while operating in closed loop vector mode (AA121 = 10).

**Shock-Load Prevention** – When the VFD reaches a constant speed above the low-speed frequency setting, the VFD will monitor the required torque and set the forward driving torque limit to the required torque + a torque padder value. If the required torque changes rapidly the torque limit will react and the VFD will reduce the set frequency to low speed almost instantly. Once the actual frequency becomes less than or equal to the low-speed frequency the torque limit will be reset to the default torque limit value and the frequency will be allowed to increase again.

**Shock-Load Detection** – When the VFD reaches a constant speed above the low-speed frequency setting, the VFD will monitor the required torque and set the forward driving torque limit to the required torque + a torque padder value. If the required torque changes rapidly the torque limit will react and the VFD will trip with an E54 fault. This function is typically used as a snag protection function.

If the shock-load function is activating under normal condition you will need to increment the shock-load torque padder. Be sure to only increment the shock-load torque padder by a value of 1 until the shock-load function is no longer activating until normal conditions.

Function	Parameter	Example Value
Shock-Load Function	UE-52	0 = Disabled
		1 = Shock-Load Prevention Enabled
		2 = Shock-Load Detection
Shock Load Torque Padder Value	UE-53	8 % (default)

## MOTOR BRAKE PARAMETERS

While operating in closed loop vector mode (AA121 = 10) the motor brake release and set frequencies are controlled automatically and typically do not require adjustment.

When operating in open loop mode (AA121 = 1 thru 9) the motor brake release and set frequencies are controlled by parameters that can be adjusted but typically do not require adjustment.

It is rare for field adjustments to be made for any of these parameters. Please consult Detroit Hoist before adjusting any motor brake parameters.

When switching between VFD Control Modes (AA121) the internal firmware will automatically assign the AL relay function CC-07 to the default value listed below. Relay 16 can be used in tandem with AL for added safety by changing VFD parameter CC-06 to the value set in CC-07 and moving the wire from AL1 to 16A and wiring AL1 to 16C.

**IMPORTANT** – When switching between VFD Control Modes (AA121) the internal program will automatically assign the AL relay function CC-07 to the default value listed below it does NOT set CC-06 #16 relay automatically.

VFD Control Mode	Function	Parameter	Value
Open Loop	Brake release frequency	CE-10	2.50 Hz (default)
Open Loop	Brake set frequency	CE-11	3.50 Hz (default)
Open Loop	Brake release delay time	UE-25	45 ms (default)
Open Loop	Brake Function	CC-44	003:FA2
Open Loop	AL relay output function	CC-07	63:LOG2
Closed Loop	Brake set delay time	UE-27	45 ms
Closed Loop	Brake release delay time	UE-28	45 ms
Closed Loop	AL relay output function	CC-07	62:LOG1
<p>The brake release delay time is used to compensate for delayed brakes and help prevent driving through the motor brake.</p> <p>The brake set delay time is used to compensate for delayed brakes and help prevent nuisance brake slip detection.</p>			

## ENCODER-BASED OPERATIONAL HOOK BLOCK LIMITS (CLV)

The VFD has the capability to utilize the motor encoder to create digital upper and lower operational hook block limits. This is done with the use of the encoder from the motor while operating in closed loop vector control only (AA121 = 10) and with the encoder-based limits enabled (UE-33 = 1 or 2). The VFD will store the pulse data on power cycle. If power is removed during operation or the motor is rotated without power on, the encoder limit areas may shift and may need to be reset. If an encoder fault occurs or the VFD's control mode is changed from AA121 = 10 then encoder-based limits will need to be reset.

If an external rotary/geared limit is to be used for operational hook block limits, you will need to disable this feature by setting parameter (UE-33 = 0).

**HOW IT WORKS** – The encoder-based limit system utilizes an upper limit, upper limit approach zone, lower limit, and lower limit approach zone. The upper and lower approach zones can be configured separately. The approach zones will limit the VFD's frequency to low/1st speed and will ignore all other speed commands when traveling into the zone's direction. When traveling out of the approach zones high speed commands will be allowed. The approach zones are used to prevent over travel through the upper and lower limits when in high speed. The approach zones will automatically adjust when the VFD is operating in auto-speed.

Manual adjustments to the approach zone or stopping pulse count should be used with caution in which to prevent over travel. When adjusting the deceleration time longer than the factory settings the approach zone pulse count and stopping pulse count may need to be increased to prevent over travel.

If additional digital inputs are required for other functions, the factory program and reset terminal knife disconnect switches can be disconnected and the encoder-based limits can be configured for parameter use UE-33 = 2. Make sure to change UE-33 = 2 before removing the switches or the limits may need to be reset.

## ENCODER-BASED LIMITS PARAMETERS (CLV)

Function	Parameters	Value	Program Version#
<b>Encoder-Based Limits Mode</b>	UE-33	0 = Disabled	V27 - V28
		1 = Enabled Using External Switches	V27 - V28
		2 = Enabled Using Parameters	V27 - V28
<b>Limits Program Mode</b> * Only when UE-33 = 2	UE-66	0 = Program Mode OFF	V27 - V28
		1 = Program Mode	V27 - V28
		2 = Program Mode with Position Reset	V27 - V28
<b>V27 Upper Limit Approach Zone Pulse Count</b>	UE-63	10240 pulses (default)	V27
<b>V27 Lower Limit Approach Zone Pulse Count</b>	UE-64	10240 pulses (default)	V27
<b>V28 Upper &amp; Lower Approach Zone Rotation Count</b>	UE-64	20 rotations	V28
<b>Pulse Count for Stopping</b>	UE-65	768 pulses (default)	V27 - V28
<b>Lower Limit Pulse Count</b>	AE-22	Stored pulse count from setting limits	V27 – V28

## SETTING ENCODER-BASED LIMITS (CLV)

Use the step chart below to set the encoder-based limits. If using switches from the factory use the image below of the blue terminal knife disconnect as reference.

Step	Instruction
<b>Verify</b>	Verify the encoder-based limits are enabled by navigating to VFD parameter UE-33 and verifying the value is set to 1 or 2. If you are using external switches (UE-33 = 1) then use the steps <u>WITHOUT</u> the asterisk *. If you are using the parameters (UE-33 = 2) then use the steps with the asterisk *
<b>Using Switches (UE-33 = 1)</b>	
<b>1</b>	Locate the blue terminal knife disconnect labeled “PP” and pull the yellow tab to the open position, this will put the limits into program mode.
<b>2</b>	Run the hook block to the desired upper limit position and wait for the motor brake to set.
<b>3</b>	Locate the blue terminal knife disconnect labeled “PR” and pull the yellow tab to the open position and wait 2 seconds then close the “PR” tab, this will clear the current position pulse count.
<b>4</b>	Run the hook block to the desired lower limit position and wait for the motor brake to set.
<b>5</b>	Close the yellow tab on the “PP” terminal knife disconnect.
<b>6</b>	Verify operation of the upper and lower limits.
<b>* Using Parameters (UE-33 = 2)</b>	
<b>*1</b>	Navigate to VFD parameter UE-66 and set the value to 1 and save it.
<b>*2</b>	Run the hook block to the desired upper limit position and wait for the motor brake to set.
<b>*3</b>	Navigate to VFD parameter UE-66 and set the value to 2 and save it, wait 2 seconds, and change it back to 1. This will clear the current position pulse count.
<b>*4</b>	Run the hook block to the desired lower limit position and wait for the motor brake to set.
<b>*5</b>	Navigate to VFD parameter UE-66 and set the value to 0 and save it.
<b>*6</b>	Verify operation of the upper and lower limits.

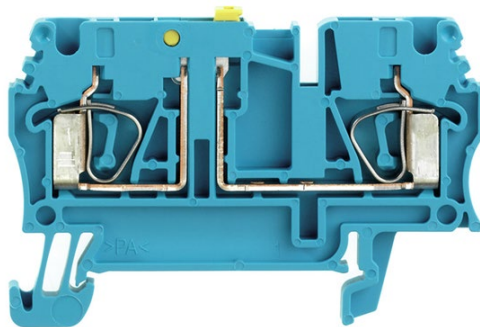

*Encoder Limits Program and Reset Knife Disconnect*



## OUTPUT SIGNAL FOR ENCODER LIMITS (CLV)

When using the encoder-based limits it is possible to configure available digital outputs for upper and lower limit indication outputs. Use the chart below. A separate external 24vdc supply is required to be added to power the additional outputs.

Function	Parameters	Value
Upper Encoder Limit Reached	CC-03 thru CC-05	070: MO2
Lower Encoder Limit Reached		071: MO3
Encoder Limit Approach Zone		072: MO4

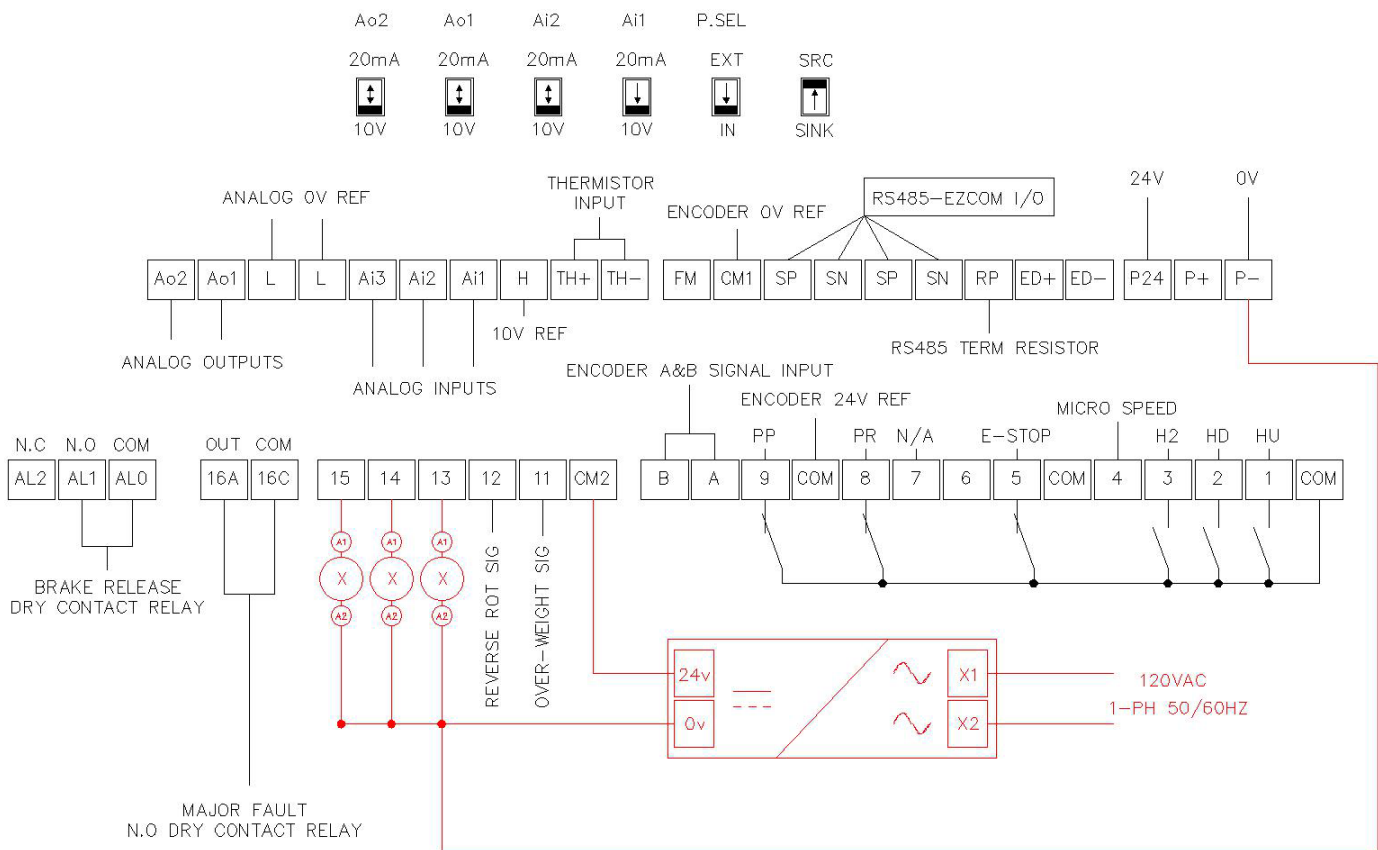

## ENCODER PARAMETERS (CLV)

In most applications the encoder will terminate at the main body digital input terminals and the parameters with Main Body will apply. In some special cases an external feedback card will be installed and the parameters with P1-FB will apply. In the case of the P1-FB card CA-90 will need to = 00: disabled.

Encoder Phase Position is used to reverse the encoder phases through parameters instead of switching the signal wires in the case of mounting an encoder backwards or connecting the wires in a reverse order.

The Speed Feedback Monitor dA-08 will show the detected frequency coming from the encoder. Verify the shown frequency matches the direction of the hoist motion (Hoist up positive frequency / Hoist down negative frequency).

The Current Position Monitor dA-20 will show you the current position in pulses from the upper limit. This values typically is shown as a negative value since the upper limit is 0.

If there is reason to believe there is induced interference try adding a cable on ferrite core magnet double wrapped at each end of the encoder wire (see image below).

Function	Parameter	Example Value
Main Body Encoder PPR	CA-81	512
Main Body Encoder Phase Position	CA-82	00: Phase A-Lead
		01: Phase B-Lead
Main Body Encoder Input Function	CA-90	02: Speed Feedback
P1-FB Ext Card Encoder PPR	ob-01	512
P1-FB Ext Card Encoder Phase Position	ob-02	00: Phase A-Lead
		01: Phase B-Lead
Encoder Speed Feedback Monitor	dA-08	x.xx Hz
Current Position Monitor	dA-20	xxxx pulses



*Encoder Clamp on Ferrite Core Magnet*

## LOAD FLOAT (CLV)

Load float is term used in closed loop vector control where the VFD can hold a load at 0hz / 0 speed without the use of the motor brake. This function is available when operating in closed loop mode (AA121 = 10) and will greatly increase the life of the motor brake by only using it as a holding/parking brake and not a dynamic brake in normal operation. Load float also gives the operator time to make rapid precise movements.

HOW IT WORKS – When the hoist is commanded to stop in a normal operation the hoist will decelerate to 0hz and start the load float timer. The load float timer will reset if a directional command is given before the load float timer expires. Once the load float timer expires the motor brake will set and all directional commands will be ignored, and the brake slip test will begin.

Function	Parameters	Example Value
Load Float Time	UE-29	250 (2.5 seconds)
Note – The load float time can be increased but if extending the load float time to a large amount of time an external motor cooling device may be required or damage to the motor can occur.		

## MOTOR TORQUE PROVING (CLV)

Motor torque proving is safety check feature that checks to make sure the motor can generate sufficient torque to current ratio before releasing the motor brake. This is safety check feature is only available when operating in closed loop vector control only (AA121 = 10).

HOW IT WORKS – The motor torque proving test works by applying a calculated torque value to the motor at 0hz / 0 speed at the beginning of each lift and verifies the motor achieves the calculated torque and current prior to releasing the motor brake. Upon powering up, fault reset, and or E-stop condition the value is 100%, and after the first initial lift it will be calculated based off the last suspended load at the end of the lift cycle. When the VFD detects the motor has generated sufficient torque within the allowed test time the motor brake will be released and the VFD will accelerate to the set frequency command after the motor brake delay time has expired. If the motor fails to generate sufficient torque within the allowed test time the VFD will trip with and E51 fault code.

**IMPORTANT!** – Disabling this feature is not recommended unless troubleshooting without a load. Disabling this safety check feature with a load suspended may result in dropping of the load.

TROUBLESHOOTING E51 – If an E51 fault occurs check the motor brake air gap. If the motor is turning during the test the VFD will try and compensate by lowering the output torque value to maintain the 0hz/0 speed command and result in a E51 fault. Also check to make sure the motor connections are secure and making good connection. If the motor cannot provide the correct amount of current to torque ratio due to a burnt motor then an E51 fault will occur.

Function	Parameters	Value
Motor Torque Proving Test	UE-30	0 = Disabled
		1 = Enabled
Motor Torque Proving Test Max Allow Time	UE-32	400 (4.0 seconds)
Setting the motor torque proving test max allow time to a low value can result in E51 faults.		

## MOTOR BRAKE SLIP DETECTION (CLV)

Motor brake slip detection is safety check feature that checks to make sure the motor brake can hold the suspended load at the end of each lift cycle prior to removing complete power from the motor. This is safety check feature is only available when operating in closed loop vector control only (AA121 = 10).

**HOW IT WORKS** – At the end of a lift cycle and when the load float time expires the motor brake will be commanded to close. Once the motor brake closes and the brake delay set time has expired the test will begin. The VFD will start to controllably limit the output torque to the motor while checking for movement on the motor shaft via the encoder signal. If a slip is detected the VFD will restore the torque limiter back to the default value and hold the load at 0hz / 0 speed, any digital outputs configured for 75:M07 will turn on for brake slip detection indication, and the hoist up and high-speed function will be disabled and only hoist down will be allowed. Once the test passes either by lower the load to the ground or removing the weight the VFD will trip with a E50 fault code to indicate a brake slip was detected and the motor brake should be inspected immediately!

**HOW TO KNOW IF A BRAKE SLIP HAS OCCURRED** – The VFD will prevent a hoisting / forward direction and only allow a lowering or reverse direction. A indicating light circuit can be added to help identify when a brake slip has been detected. 24vdc digital output 13 is factory configured to turn on when a brake slip has been detected. Adding a 24vdc control relay to the output will allow you to add an indicating light.

**IMPORTANT!** – If a brake slip is detected do not turn off power or load may fall, lower load, and inspect motor brake immediately!

**IMPORTANT!** – Disabling this feature is not recommended unless troubleshooting without a load. Disabling this safety check feature with a load suspended may result in dropping of the load.

**TROUBLESHOOTING E50** – If an E50 fault occurs check the motor brake immediately. If the motor brake is verified, then check for electromagnetically induced signals on the encoder line, if there is induced signals try adding a ferrite core magnet double wrapped around the encoder wire. Verify the encoder wire shield or drain wire is terminated to a ground source. If the motor brake is delayed and is casing premature trips, then increase the motor brake delay set time.

Function	Parameters	Value
Motor Brake Slip Detection Test	UE-34	0 = Disabled
		1 = Enabled
Motor Brake Slip Detection Max Pulse Count	UE-35	5 pulses (default)
<b>IMPORTANT!</b> - Increasing the detection pulse count can result in a delayed detection or no detecting and load may fall.		
Motor Brake Slip Detection Torque Reduction Time	UE-37	15 (0.15 seconds default)
Motor Brake Slip Detection Output Signal	CC-03 – CC-06 CC-03 (factory default)	75:M07

## TANDEM HOIST EZCOM (SPEED / COMMAND / STATUS SYNCING)

Tandem hoist EZCOM can be used when 2 hoists are used in tandem operation and require the frequency, hook limit status, command status, and fault status to sync between each hoist.

The VFD's will need to be configured to communicate between each other and the internal logic activated. A 2-wire shielded cable is required to connect between the VFD's SN/SP RS485 terminals (Belden 9538 type cable is recommended). Typically, A/B relays will be used to supply an input to the VFD to activate the syncing logic when in tandem mode, digital input 6 is typically used.

HOW IT WORKS – The VFD's use the SN/SP RS485 terminals to send frequency, drive status, and command status Modbus registers values between each other. While in sync mode the VFD's compare the directional commands based on conditional internal logic, which ensures if a hoist reaches a limit, or loses a command signal the opposite hoist will follow the command. While in tandem mode the VFD's also compare frequency values and always sync to which VFD has the lowest frequency value, this ensures the set frequencies always match.

NOTE – If the VFD's are configured for EZCOM tandem sync (UE-43 > 0) and the EZCOM communication is disconnected (db-08 = 9999) the hoists will ignore all directional commands even when in individual mode and the communication disconnection must be addressed. The only exception is if a brake slip is detected the VFD will ignore the EZCOM communication disconnection and operated in an individual mode configuration.

TROUBLESHOOTING EZCOM COMMUNICATION DISCONNECTION (db-08 = 9999) – Use the VFD monitor parameter db-08 to monitor the EZCOM communication disconnection. If the value shown in db-08 = 9999 then the communication is disconnected or timed out or not configured correctly. Check the wiring between the VFD's SN & SP terminals. Also make sure the VFD's power up at the exact same time or use a digital input to active the EZCOM communication by configuring one of the available digital inputs to 098:ECOM if power cannot be verified at the same time. Verify EZCOM parameters are configured correctly using the EZCOM parameter chart on the next page.

## EZCOM SETUP GUIDE

Step	Instruction
1	Configure the VFD's parameters using the EZCOM parameter chart. Most of the parameters should already be configured and only the ones highlighted in yellow should need to be changed.
2	Power down both VFD's and connect the 2-wire shielded cable to the corresponding SN & SP terminals as shown in the EZCOM circuit wiring example on the next page. Be sure to add the RS485 termination jumper to the B hoist VFD as shown on the EZCOM circuit wiring example.
3	Add the tandem activation circuit to digital input 6 on each VFD as shown in the EZCOM circuit wiring example on the next page.
4	Power up the VFD's together at the same time and verify the communication is not disconnected by using the monitor parameter db-08. If The value in db-08 = 9999 then troubleshooting is required.
5	Operate the hoists in tandem and individually and verify correct operation.

## EZCOM PARAMETERS

Function	Parameter	Hoist A	Hoist B
Digital Input 6 = Tandem Activation	CA-06	95	95
EZCOM sync mode	UE-43	1 = enabled speed + command	1 = enabled speed + command
EZCOM node ID	CF-02	1	2
EZCOM communication error select	CF-05	0 = trip with error	0 = trip with error
		02 = prevent run / without error	02 = prevent run / without error
EZCOM communication time out	CF-06	1.00 seconds	1.00 seconds
EZCOM communication wait time	CF-07	2 ms	2 ms
EZCOM communication mode	CF-08	03 = EZCOM Administrator	02 = EZCOM
EZCOM start node ID	CF-20	1	1
EZCOM end node ID	CF-21	2	2
EZCOM communication start method	CF-22	00 = digital input 098:ECOM	00 = digital input 098:ECOM
		01 = always start on power up	01 = always start on power up
EZCOM data size	CF-23	3	3
EZCOM destination address 1	CF-24	2	1
EZCOM destination register 1	CF-25	480B	480B
EZCOM source register 1	CF-26	277E	277E
EZCOM destination address 2	CF-27	2	1
EZCOM destination register 2	CF-28	480C	480C
EZCOM source register 2	CF-29	480D	480D
EZCOM destination address 3	CF-30	2	1
EZCOM destination register 3	CF-31	480E	480E
EZCOM source register 3	CF-32	480F	480F

# EZCOM CIRCUIT WIRING

EZCOM wiring example circuit. Make sure the VFD#2 has the RS485 termination jumper installed between RP and SN as shown below. Make sure to bond terminals CM1 as shown below. Ground the shield of the communication cable only at one end.

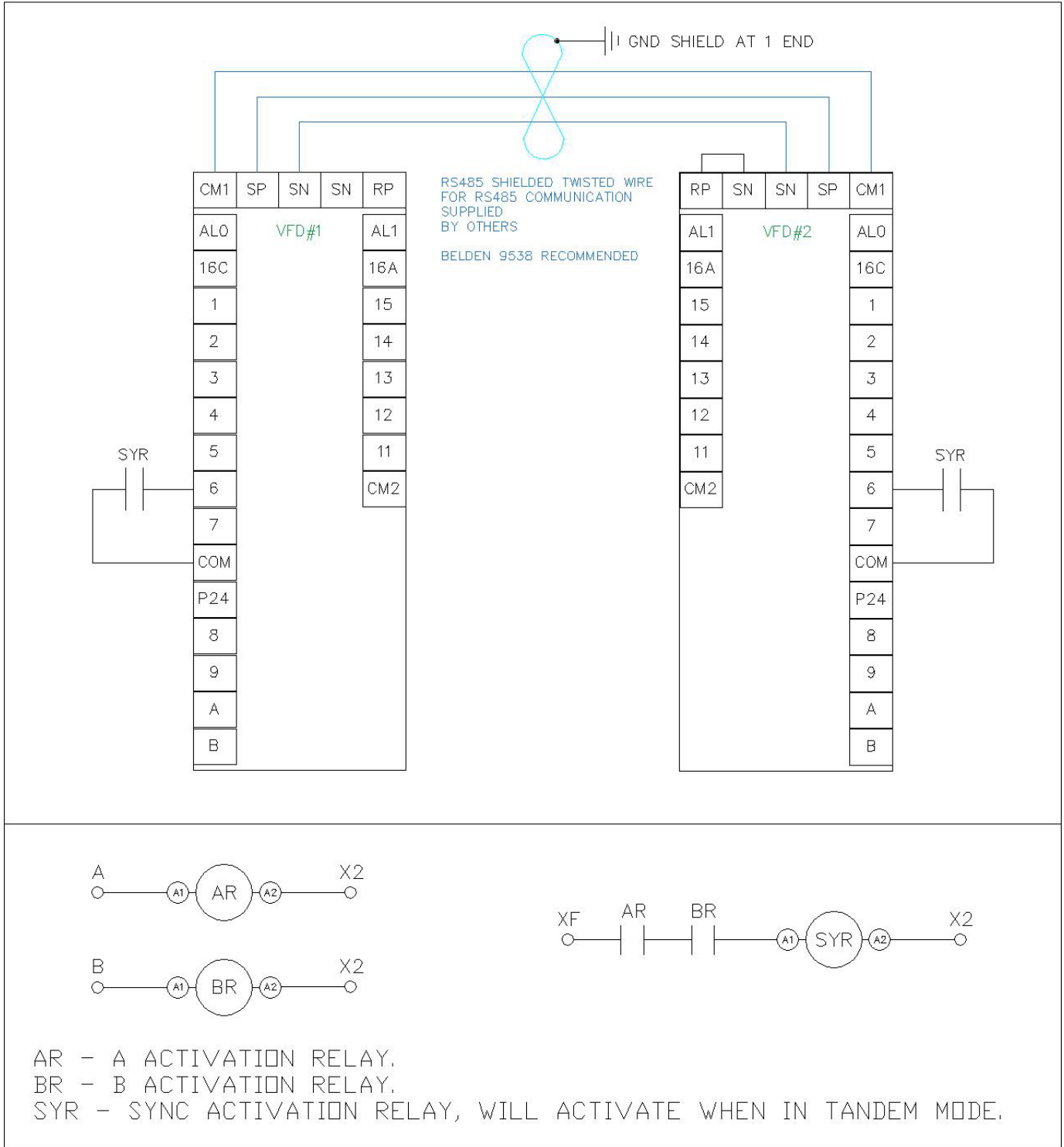

## HOOK BLOCK SYNCING / PULSE TRAIN POSITION COMMAND (CLV)

This information is used as reference only and if a field update to hook position sync is required contact Detroit Hoist for assistance to ensure proper setup. This function is only available when operating in closed loop control mode AA121 = 10.

Hoist block syncing also known as position syncing can be used to maintain hook position between the main and follower hoist VFD. This function also allows for the hook blocks to be off set. This hook block syncing is typically used when a load beam / spreader beam is used with tandem hoists to lift a load and require the hook block positions to maintain position.

HOW IT WORKS – The VFD’s use the SN/SP RS485 terminals to send frequency reference, drive status, and command status Modbus registers values between each other. The VFD’s also required the external encoder feedback card (P1-FB) connected. The main hoist will send a 1:1 pulse train from the encoder card to the pulse train input on the follower encoder card. When in sync mode the follower VFD will change over to pulse train position command mode and the frequency and position is based on the deviation between the main and follower. When in pulse train position command mode, the standard acceleration and deceleration times are ignored and are based on the position loop gain, forward feed gain and the position deviation from the main VFD.

SETUP – This function works in combination with the EZCOM function, please use the EZCOM SETUP GUIDE before configuring the VFD’s for hook block syncing. Once the EZCOM function is configured and communication is verified proceed to the PULSE TRAIN POSITION COMMAND PARAMETERS.

### PULSE TRAIN POSITION COMMAND PARAMETERS (CLV)

Configure the parameters below after the EZCOM parameters have been configured and verified. After settings the parameters below power down the VFD’s and proceed to the PULSE TRAIN POSITION COMMAND WIRING EXAMPLE.

Function	Parameter	Hoist A	Hoist B
Main Body Encoder Input	CA-90	0 = disabled	0 = disabled
P1-FB Encoder Card Encoder PPR	ob-01	512 ppr	512 ppr
P1-FB Encoder Card Encoder Phase	ob-02	0 = phase-A lead	0 = phase-A lead
		01 = phase-B lead (typical)	01 = phase-B lead (typical)
Pulse train detection selection	ob-10	n/a	01 = pulse train position reference
Pulse train signal input configuration	ob-11	n/a	00 = 90° shift pulse train
Position feed-forward gain	AE-06	n/a	0.00 – 5.00 (0.00 typical)
Position loop gain	AE-07	n/a	0.00 – 50.00 (50.00 typical)
Pulse train position deviation monitor	dA-26	n/a	0 ~ 2147483647 pulses
Position deviation max deviation range	bb-86	n/a	10240 pulses
Position deviation max time before error	bb-87	n/a	1.0 seconds
Main / Follower designation	UE-49	1	2

### TROUBLESHOOTING PULSE TRAIN POSITION COMMAND (CLV)

After the wiring and parameters have been set if the follower hoist does not rotate in the correct direction, then you will need to reverse the pulse train connection phase by switching the position of the SAP & SAN wires to the position of SBP & SBN. If you receive a E52 speed deviation error then the phasing of the encoder wires might be backwards, trying to switch the position of the EAP & EAN wires to the position of EBP & EBN.



## PULSE TRAIN POSITION COMMAND WIRING EXAMPLE (CLV)

The external encoder card P1-FB will need to be installed in the center option card slot #2 on both VFD's. The reference image below is based on a non-inverted encoder signal connection. If the connected encoder signal is inverted then the connections from AP,AN,BP,BN to SAP,SAN,SBP,SBN will need to be inverted as well.

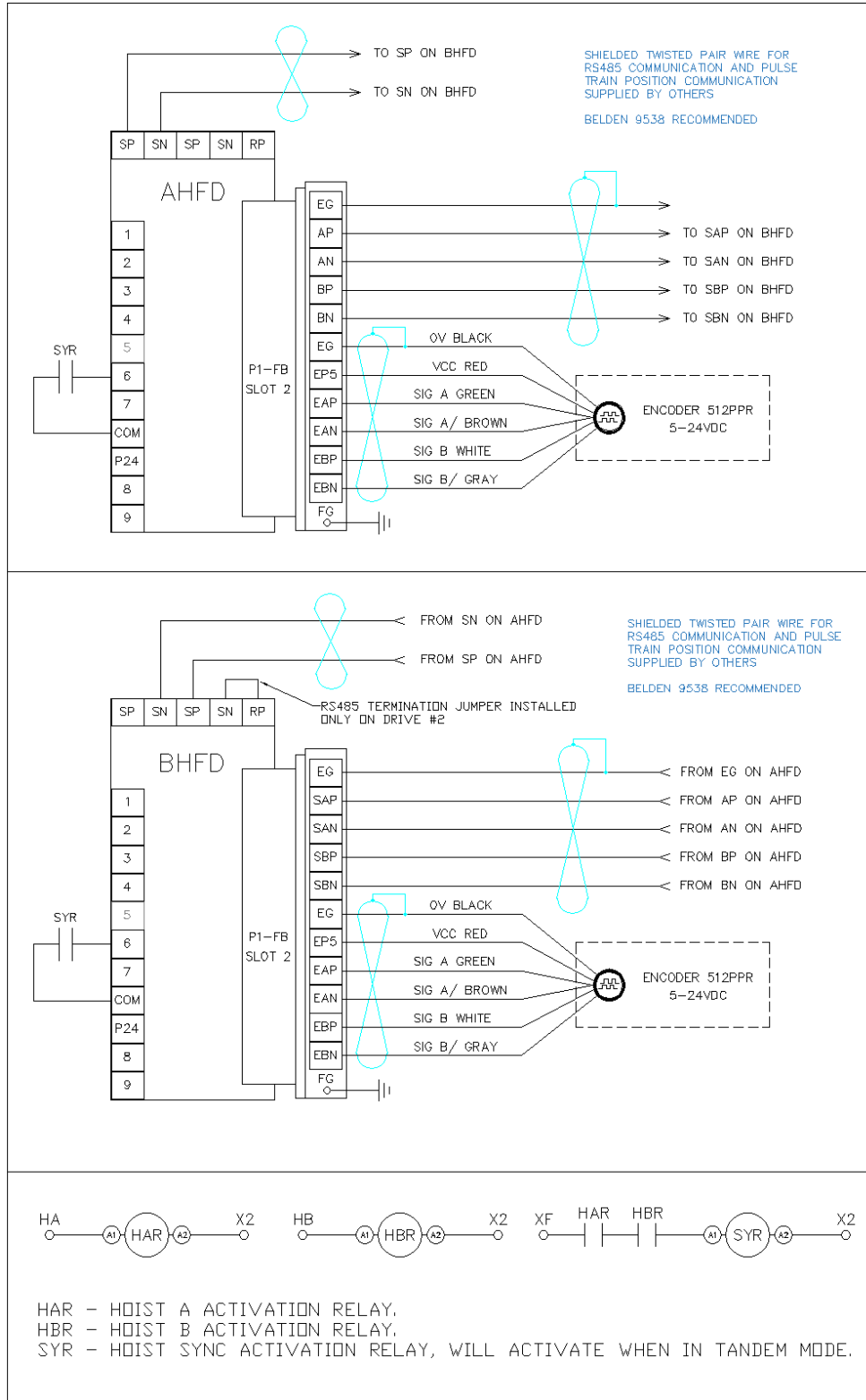

## VFD CONTROL MODES

If you need to change the VFD control mode for testing, troubleshooting, or changing an open loop hoist to closed loop reference the parameter chart below. Only choose the options provided below that are verified to be compatible with the DH firmware.

NOTE – Once you have changed the control mode it is recommended to cycle power.

**IMPORTANT!** – It is not recommended to change the control mode from closed loop to open loop unless for troubleshooting purposes with an empty hook!

Function	Parameters	Value
VFD Control Mode	AA121	10: Closed Loop Vector
		09: Open Loop 0-Hz Domain SLV
		08: Open Loop SLV
		03: Open Loop Automatic Torque Boost
		00: Open Loop Constant Torque
<b>IMPORTANT!</b> – NEVER change a closed loop VFD to open loop with a load on the hook or load may fall!		

## MANUAL TORQUE BOOST / AUTOMATIC TORQUE BOOST PARAMETERS

The manual and automatic torque boost parameters are only valid for VFD control modes 00 CT and 03 ATB.

Function	Parameter	Example Value
Manual Torque Boost Operation	Hb140	00: Disabled
		01: Always
		02: Forward Direction
		03: Reverse Direction
Manual Torque Boost Value	Hb141	0 – 20 (4.0 default)
Manual Torque Boost Peak Speed Boost to % of base frequency	Hb142	0 – 50 (4.0 default)
Automatic Torque Boost Voltage Comp Gain	HC101	0 – 255 (100 default)
Automatic Torque Boost Slip Comp Gain	HC102	0 – 255 (100 default)

## AUTO-TUNING

Field auto-tuning is generally not required. The VFD will be configured from the factory for the connected motor. If field auto-tuning is required, please use the step chart below.

NOTE – The E-stop / maximum upper limit will retain function to prevent over-travel into the frame. The VFD will automatically control the AL relay output for brake release command during auto-tuning.

**IMPORTANT!** – If a secondary brake is connected make sure the corresponding brake release terminal function has been assigned to the same as the primary brake release function.

Step	Instruction
1	Remove all attached loads from the hook. If you plan to do a rotational auto-tune remove the wire rope from the drum.
2	Navigate to VFD parameter HA-01 and select 01: No Rotation for a static tune or 02: Rotation for a rotational tune. Save the selection
3	On the VFD press the GREEN RUN button once and the auto-tune process will start. If there is an issue or you wish to stop the auto-tune process, then press the RED STOP/RESET button.
4	Once the auto-tune process is complete the display will show the results of the R1,R2,L for a static tune or R1,R2,L,IO,J for a rotational tune. The auto-tune data will automatically be applied to the motor constant parameters.
5	The auto-tune process is now complete.

## MOTOR CONSTANTS

Function	Parameter	Example Value
Motor Capacity	Hb102	Motor in kW (7.50) kW
Motor Poles	Hb103	01: 4 pole motor
Motor Voltage	Hb106	230V / 460V
Motor FLA	Hb108	14.0 A
Motor R1 Constant	Hb110	0.459108 ohms
Motor R2 Constant	Hb112	0.502048 ohms
Motor L Constant	Hb114	8.316144 mH
Motor Io Constant	Hb116	6.11 A
Motor J Constant	Hb118	0.03176 kgm2

## SPEED DEVIATION (CLV)

The speed deviation error detection function judges that the deviation is excessive if the deviation between the frequency command and the feedback speed becomes large. Speed deviation is the difference between [dA-12] Output frequency monitor and [dA-08] detected frequency monitor.

When the absolute value of speed deviation has exceeded [bb-83] Speed deviation error detection level and [bb-84] Speed deviation error detection time has elapsed, it is judged as a speed deviation error.

The speed deviation error mode can be configured for the internal program to generate the fault (E52) or set for the standard VFD fault E105. The internal program has an added loop logic in which the speed deviation needs to be confirmed for a preset amount of program cycles which helps prevent nuisance trips.

Adjustments typically not required. Please consult Detroit Hoist before changing any speed deviation related parameters.

NOTE – A sudden increase in load like shock loading can cause a speed deviation error (E52 / E105).

NOTE – The speed deviation function cannot be disabled when operating in closed loop (AA121 = 10) because the function is a safety function and is referenced to detect a problem with the encoder feedback signals.

Function	Parameter	Example Value
Speed deviation error mode	bb-82	0 = E52 error
		1 = E105 error
Speed deviation error level	bb-83	7.5 %
Speed deviation error detection time	bb-84	0.1 sec
Speed deviation program cycles * Valid when bb-82 = 0	UE-58	5 cycles

## DYNAMIC BRAKING

The dynamic braking is used to electronically brake the motor during deceleration. Dynamic braking required the use of a braking resistor or a regenerative converter. The parameters below only apply when using a resistor.

**Load-Brake**– The internal load-brake absorbs 99% of the dynamic braking. The dynamic braking usage ratio should be set to 3% to detect when the load-brake becomes worn, and maintenance is required. Setting the dynamic braking usage ratio greater than 3% will result in the resistor becoming hot and damaging the VFD.

**Non-Load-Brake**–The dynamic braking usage ratio should be set to 100%.

**Dynamic braking mode**– By default this is set to 2:enabled all the time. This helps suppress the DC BUS voltage from causing an E07 fault during idle if power spikes occur randomly. If the power becomes high for a long period of time this will cause an E06 fault to occur.

**Dynamic braking voltage activation level**– This is the DC BUS voltage level in which the braking chopper circuit will activate. In some cases, with high input power, you may need to adjust the level or an E06 will occur.

Function	Parameter	Values	Factory Default
Dynamic braking allowable usage ratio	bA-60	Load-Brake 3%	3%
		Non-Load-Brake = 100%	100%
Dynamic braking Mode	bA-61	0 = disabled	1 = enabled during RUN
		1 = enabled during RUN	
		2 = enabled all the time	
Dynamic braking DC BUS voltage activation level	bA-62	200V Class – (330 – 400V)	380V
		400V Class (660 – 800V)	780V

## OVER-SPEED (CLV)

The over-speed error detection function judges that the speed is excessive if the feedback speed exceeds the over-speed level. Whether the speed is excessive is determined according to the feedback frequency displayed on [dA-08] Detected frequency monitor. When the speed has exceeded [bb-80] Over-speed error detection level and [bb-81] Over-speed error detection time has elapsed, it is judged as an over-speed error. When an over-speed error occurs, the inverter trips with [E107] Over-speed error.

Function	Parameter	Example Value
Over-speed error detection level setting	bb-80	135%
Over-speed error detection time	bb-81	0.5 sec

## CARRIER FREQUENCY

The carrier frequency is the frequency at which the element that controls the inverter output changes. The carrier frequency can be changed using the [bb101] setting. It is also effective in avoiding resonance of mechanical systems and motors.

If the [AA121] control mode selection is automatic torque boost (03), sensorless vector control (08), zero speed area sensorless vector control (09), or vector control with encoder (10) set the carrier frequency to 2.1 kHz or higher.

NOTE – Increasing the carrier frequency higher than 5.0 kHz will require the VFD to be de-rated due to thermal increase on the output transistors. Increasing the carrier frequency will increase the leakage current and appropriate measures should be taken to correct for the leakage current.

Function	Parameter	Example Value
Carrier frequency	bb101	5.0 kHz

## GROUND FAULT PROTECTION

This is a function to protect the inverter by the detection of ground faults between the inverter output and the motor at power-on. The function doesn't work when there is a voltage induced in the motor due to idling or when the inverter trips.

Function	Parameter	Example Value
Ground fault protection	bb-64	0 = disabled
		1 = enabled

## INPUT PHASE LOSS PROTECTION

When [bb-65] input phase loss selection is set to 01, when a missing phase is detected in input line, the inverter turns OFF its output. This protection function is used to prevent system failure due to unstable motor operation when a phase loss occurs by breakage of the input power cable.

When the input phase loss protection function has been enabled, an input phase loss error [E024] will occur if a phase loss state due to disconnection or breakage of the input power cable continues for 1 second or more.

When 3-phase AC is not supplied to power supply terminals R, S, and T, such as in cases where DC voltage is supplied to R and T or between P and N of the inverter, this function is disabled regardless of the setting for [bb-65].

Function	Parameter	Example Value
Input phase loss protection	bb-65	0 = disabled
		1 = enabled

## OUTPUT PHASE LOSS PROTECTION

While operating in closed loop mode (AA121 = 10) this protection function should be disabled due to 0hz load floating. The motor torque proving, and speed deviation protection functions will provide the protection function.

When the output phase loss selection [bb-66] is set to 01, when a loose connection or disconnection of output line, disconnection inside the motor, etc. is detected, the inverter turns OFF its output. Detection of phase loss state is executed in the section between 5Hz to 100Hz.

When the output phase loss protection function has been enabled, an output phase loss error [E034] will occur if a phase loss caused by disconnection or breakage of the motor cable continues.

If the capacity of the drive motor is smaller than that of the inverter, the inverter may detect an output phase loss erroneously. In this case, decrease the value of [bb-67] or set [bb-66] to 00.

If the carrier frequency [bb101] is low, the inverter may detect an output phase loss mistakenly. It may improve by increasing the value of the carrier frequency [bb101].

Function	Parameter	Example Value
Output phase loss protection	bb-66	0 = disabled
		1 = enabled
Output phase loss detection sensitivity	bb-67	1 ~ 100%

## INPUT POWER SUPPLY OVER-VOLTAGE PROTECTION

This function will output an error [E015] when the P-N voltage exceeds the voltage level set in the incoming overvoltage level selection [bb-62] for 100 seconds continuously due to incoming voltage.

Function	Parameter	Example Value
Power supply over-voltage error selection	bb-61	0 = warning
		1 = error [E015]
Power supply over-voltage level	bb-62	600v – 820v (400v models) 300v – 410v (200v models)

## OVER-TORQUE DETECTION

The over-torque detection function is used while operating in control modes (AA121) sensorless vector control (08), zero speed area sensorless vector control (09), or vector control with encoder (10). If the output torque exceeds the conditional quadrant set value an over-torque error will occur [E053].

Function	Parameter	Example Value
Over torque level (forward driving torque)	CE120	0 ~ 500%
Over torque level (reverse regen torque)	CE121	0 ~ 500%
Over torque level (reverse driving torque)	CE122	0 ~ 500%
Over torque level (forward regen torque)	CE123	0 ~ 500%

## TORQUE LIMIT

The torque limit function is used while operating in control modes (AA121) sensorless vector control (08), zero speed area sensorless vector control (09), or vector control with encoder (10). This function can be used to protect the hoist and crane from damage occurring due to snagging or over-loading by limiting the forward driving torque. The motor will stall if the torque becomes greater than this value. The value is presented as a whole number. Be sure to set this value 10% higher than the maximum required torque under 100% load operating at high speed.

Example – 200.0% ( UE-68 = 2000 )

Function	Parameter	Example Value
Torque Limit (forward driving torque)	UE-68	2000 (default)



## MONITOR DIGITAL INPUTS

The Hitachi VFD's have a monitor function that will display the status of the 24vdc digital inputs 1 thru 9 & A, B. Unlike the WJ200 the P1 has a GUI screen and supports up to (3) monitors on the main screen. By default, the digital input monitor should be located on the bottom of the main screen on power up. If the main screen does not show the digital input monitor, you can view it by navigating to the monitor parameter dA-51.

The P1's digital input monitor will display each input using a **L** or **H** that represents LOW or HIGH. The inputs on the monitor read right to left corresponding with digital inputs 1 thru 9 & A, B.

**L** will indicate the input is LOW which is off / not active.

**H** will indicate the input is HIGH which is on / active.

Hitachi P1 Digital Input Monitor parameter = dA-51

The image below is a reference image to the P1 digital input monitor. This example shows digital input 5 is the only active digital input. Again, the screen reads right to left, digital input 1 is the 1<sup>st</sup> line from the right.

Left Picture – Main screen with output frequency monitor, output current monitor, input terminal monitor.

Right Picture – The scroll menu for the monitor parameter group with dA-51 highlighted.

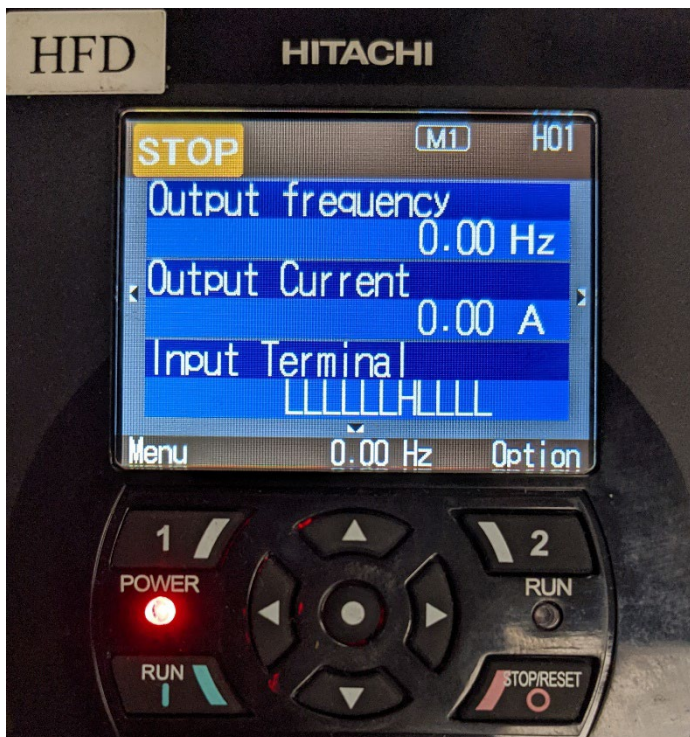

*Default Home Screen*



*dA Scroll Menu Monitors*

## MONITOR PARAMETERS

Monitor	Parameter	Brief Description
Output Frequency	dA-01	The commanded output frequency.
Output Current	dA-02	Displays the output current to the motor.
Actual Rotation Direction	dA-03	Output rotation direction (f = forward / r = reverse)
Encoder Detected Speed	dA-08	Displays the detected speed from the encoder
Output Torque	dA-17	Displays the output torque to the motor.
Current Position	dA-20	Displays the current position in pulses based on the encoder and position of 0 being the upper limit when encoder limits are in use.
Pulse Train Position Deviation Pulse Count	dA-26	Displays the pulse deviation between the main and follower drive when operating in pulse train position command mode. Only applicable on the follower drive.
Accumulated Output Power kWh	dA-36	Displays the accumulated output in kilowatt hours.
DC-BUS Voltage	dA-40	DC-BUS voltage.
Dynamic Braking Usage %	dA-41	Displays the current dynamic braking usages in percentage.
Digital Inputs	dA-51	Displays the digital input terminal status. L = OFF / H = ON Terminals 1 thru 9, A & B right to left on display
Digital Outputs and Relays	dA-54	Displays the digital outputs and relays status. L = OFF / H = ON
Analog Input Monitor Ai1	dA-61	Displays the value of the analog input.
Analog Input Monitor Ai2	dA-62	Displays the value of the analog input.
DH Program #	db-02	Displays the internal program version number.
EZCOM Communication Status	db-08	9999 = disconnected
Local VFD Command Instruction	db-10	Displays the local VFD's internal program command instruction number.
n/a	db-12	n/a
Auto-Speed Load Monitor	db-14	Displays the load value for the auto-speed function.
Brake Slip Detection Pulse Count	db-16	Displays the number of pulses detected during the brake slip detection test.
Cooling Fin Temp	dC-15	Displays the temperature of the cooling fins in Celsius.
Accumulation Number of Starts	dC-20	1-65535 cycles
Accumulated RUN Time	dC-22	1-1000000 hours
Accumulated Power-ON Time	dC-24	1-1000000 hours

## TROUBLESHOOTING E50 FAULT

WHAT IS AN E50 FAULT - An E50 fault is a brake slip detection fault. This will occur when a brake slip is detected, and the next brake slip detection test has passed usually when a load is removed or on the ground. This fault is used to alert and track that a brake slip has been detected and the motor brake should be inspected immediately before using the hoist again.

HOW TO KNOW IF A BRAKE SLIP HAS OCCURRED – The VFD will prevent a hoisting / forward direction and only allow a lowering or reverse direction. A indicating light circuit can be added to help identify when a brake slip has been detected. 24vdc digital output 13 is factory configured to turn on when a brake slip has been detected. Adding a 24vdc control relay to the output will allow you to add an indicating light.

HOW IS AN E50 FAULT DETERMINED – When the VFD is operating in closed loop vector control only (AA121 = 10) at the end of a lift cycle the motor brake is commanded to close. Once the motor brake is closed the VFD will log the encoder pulse count before the test begins, then the VFD will controllably limit the output torque to the motor in calculated cycles. As the torque is being limited the current encoder pulse count is compared against the logged encoder pulse count. If the encoder pulse count deviates by the value in parameter UE-35 = 5 pulses, then a brake slip is determined to have occurred.

The Brake Slip Detection Pulse Count monitor db-16 will display the pulses detected during the brake slip detection test. You can use this monitor to see how many pulses / how much movement is occurring during the test.

- Check the physical condition of the motor brake pads and springs.
- Check that the motor brake air gap is within the required spec for that brake. Try adjusting it to the smallest air gap allowed in the brake spec.
- Check the brake release circuit (ex. contactor, relays, wires, rectifiers) for any loose wires or stuck contacts due to dc arc pitting.
- Check to see if there is physical movement when the brake slip detection test indicates there is a slip detected. If there is no physical movement then there might be electromagnetic interference induced on the encoder line. Check and make sure the encoder shield or drain is terminated to a ground source either a ground lug or 0v terminal when connected to the main body digital inputs on the VFD. DO NOT CONNECT THE ENCODER SHIELD OR DRAIN TO THE VFD POWER GROUND TERMINAL.
- If electromagnetic interference is being induced and the shield has been properly terminated, try adding ferrite core clamps around the encoder wire with a minimum of (2) turns around the ferrite core.
- Contact Detroit Hoist for further assistance.

## TROUBLESHOOTING E51 FAULT

WHAT IS AN E51 FAULT - An E51 fault is a motor torque proving fault. The motor responded with less than the anticipated motor current.

HOW IS AN E51 FAULT DETERMINED – When the VFD is operating in closed loop vector control only (AA121 = 10) at the start of a lift cycle the VFD applies a calculated output torque to the motor and allows a specific amount of time UE-32 for the motor to respond with the motor current. If the motor responds with less than the anticipated output current based on the torque to required current calculation, then a motor torque proving fault is determined to have occurred.

- If this fault is occurring at random it might be caused due to a high load or overload. If a high load or overload occurs, it can sometimes set a value in which the VFD & motor would need to prove a value higher than allowed. Check to make sure the motor brake circuit is not dropping out randomly. Check to see if the encoder signal is unstable by using dA-08 detected speed monitor, this value while run should be close to the set-frequency value. The allowable tolerance for dA-08 is + / - 1.5hz from the commanded frequency.
- Check the physical condition of the motor brake pads and springs and make sure the VFD is not driving through the motor brake during the test. Driving through the motor brake will cause the VFD to reduce the output torque to maintain the set-frequency of 0 Hz.
- Check that the motor brake air gap is within the required spec for that brake. Try adjusting it to the smallest air gap allowed in the brake spec.
- Check that the motor connections are secure both at the VFD output terminals and at the motor junction box terminals.
- Check to see if the motor FLA constant Hb108 was changed to a larger value than what's on the motor nameplate. Please note in some cases this value in the drive may be lower due to service factor or duty cycle ratings.
- Make sure all loads are removed from the hook block and switch the VFD to an open loop control mode and see if the hoist works properly and the output current isn't high and running smoothly. This will help determine if an IGBT output from the VFD is bad.
- Check parameter UE-68 and UE-69 should have a value of 1500 – 2000.
- Check parameter UE-32 should have a value around 250 – 400.
- Check parameter bA103 = 0.00 and bA101 = 00: Disabled.
- Check parameter bA110 = 07: Keypad.
- Contact Detroit Hoist for further assistance.

## TROUBLESHOOTING E52 FAULT

WHAT IS AN E52 FAULT - An E52 fault is a speed deviation fault. The encoder detected speed deviated from the output commanded set-frequency.

HOW IS AN E52 FAULT DETERMINED – When the VFD is operating in closed loop vector control only (AA121 = 10) the VFD is constantly comparing the detected frequency from the encoder to the commanded frequency while running. If the detected frequency from the encoder deviates outside of the allowable value bb-83 for the allowable time bb-84, then a speed deviation is determined to have occurred.

- Check the encoder shaft collar is tight on the shaft and the encoder tether is secure.
- If the encoder was replaced in the field be sure to check for correct encoder signal phasing. Try switching sig A with sig B.
- If the fault is occurring at start you will need to determine if the encoder is working. To do this remove the encoder from the motor shaft and navigate to VFD parameter dA-20 the current position monitor. With the encoder in your hand rotate the encoder shaft and see if the pulse count is changing either counting up or counting down. You can also navigate to VFD parameter dA-08 and rotate the encoder shaft and see if there is any frequency being detected.
- If a load is stuck in the air, you can change the VFD control mode to open loop SLV AA121 = 08 for the purpose of lowering the load. DO NOT keep using the hoist in open loop mode if it is a closed loop hoist since the safety protections will be disabled.
- If this fault is occurring at random check to make sure the motor brake circuit is not dropping out randomly. Check to see if the encoder signal is unstable by using dA-08 detected speed monitor, this value while run should be close to the set-frequency value. The allowable tolerance for dA-08 is + / - 1.5hz from the commanded frequency.
- Contact Detroit Hoist for further assistance.
- If there is reason to believe there is induced interference try adding a cable on ferrite core magnet double wrapped at each end of the encoder wire (see image below).



*Encoder Clamp on Ferrite Core Magnet*

## TROUBLESHOOTING E53 FAULT

WHAT IS AN E53 FAULT - An E53 fault is a over-torque fault.

HOW IS AN E53 FAULT DETERMINED – When the VFD is operating in a control mode of (AA121 = 8, 9, or 10) the VFD will use the torque monitor to determine if the output torque becomes greater than the values in over-torque level parameters CE120 – CE123. If the output torque becomes greater than the over-torque levels, then an E53 over-torque fault is determined to occur.

- Check the encoder shaft collar is tight on the shaft and the encoder tether is secure.
- Check output torque monitor dA-17 without weight suspended from the hook and see if the torque is abnormally high, this might point to an issue with the output of the VFD or the motor.
- Check to see if the motor brake is releasing correctly.
- Check the over-torque levels in parameters CE120 – CE123, the normal values are 205% unless changed in the field. Make sure they are not set lower than the required torque during driving (be sure to include the torque spike during acceleration).
- If the fault is occurring at start you will need to determine if the encoder is working. To do this remove the encoder from the motor shaft and navigate to VFD parameter dA-20 the current position monitor. With the encoder in your hand rotate the encoder shaft and see if the pulse count is changing either counting up or counting down. You can also navigate to VFD parameter dA-08 and rotate the encoder shaft and see if there is any frequency being detected.
- If a load is stuck in the air, you can change the VFD control mode to open loop SLV AA121 = 08 for the purpose of lowering the load. DO NOT keep using the hoist in open loop mode if it is a closed loop hoist since the safety protections will be disabled.
- If this fault is occurring at random check to make sure the motor brake circuit is not dropping out randomly. Check to see if the encoder signal is unstable by using dA-08 detected speed monitor, this value while run should be close to the set-frequency value. The allowable tolerance for dA-08 is + / - 1.5hz from the commanded frequency.
- Contact Detroit Hoist for further assistance.

## TROUBLESHOOTING E054 FAULT

WHAT IS AN E54 FAULT - An E54 fault is a shock-load detection fault.

HOW IS AN E54 FAULT DETERMINED –When the VFD reaches a constant speed above the low-speed frequency setting, the VFD will monitor the required torque and set the forward driving torque limit to the required torque + a torque padder value. If the required torque changes rapidly the torque limit will react and the VFD will trip with an E54 fault. This function is typically used as a snag protection function.

- Check with the operator to see if there are shock-loading conditions occurring when lifting.
- Check to see if there is any mechanical binding occurring intermittently.
- Check if the acceleration times are too quick and causing a rapid increase in torque.
- Check to see if the motor brake is operating correctly.
- If this fault is occurring at random check to make sure the motor brake circuit is not dropping out randomly. Check to see if the encoder signal is unstable by using dA-08 detected speed monitor, this value while run should be close to the set-frequency value. The allowable tolerance for dA-08 is + / - 1.5hz from the commanded frequency.
- Contact Detroit Hoist for further assistance.

## TROUBLESHOOTING E001 / E005 / E039 FAULTS

WHAT IS AN E001, E005, and E039 FAULT – The 3 faults are all over-current type faults.

- If operating in closed loop AA121 = 10 then check the encoder shaft collar is tight on the shaft and the encoder tether is secure.
- When the thermal protection begins, [E005] motor electronic thermal error occurs.
- Irrespective of the thermal setting of the motor, the inverter electronic thermal protection works independently to protect the inverter.
- When the current grows rapidly, [E001] excessive current error could occur before [E005] motor electronic thermal error.
- Even if the electronic thermal level is set high, the electronic thermal for inverter works separately at frequency decreased from 5Hz and 80% at 0Hz.
- Check to see if the motor brake is releasing correctly.
- Check if parameter bC110 value is set to lower than the over-weight value or less than 125% of the motor FLA.
- Check for binding or obstructions preventing the drive train from rotating.
- If a load brake is present, check to see if the load brake is releasing and operating correctly.
- Check motor wiring.
- Contact Detroit Hoist for further assistance.

## TROUBLESHOOTING E006 FAULT

WHAT IS AN E006 FAULT – An E006 fault is a dynamic braking overuse fault. This means the dynamic braking usage ratio was exceeded or met.

- If the status of the fault was while at STOP then this typically points to the input power to the VFD increased for a long enough period of time and the braking chopper was trying to reduce the dc-bus voltage level. Check the incoming power for spikes or if large machinery is starting up causing sags and spikes. If this is the case, then try adding a line reactor in front of the main power of the crane.
- If the status of the fault was during RUN and the hoist has a load brake, then the load brake needs to be serviced. The VFD's dynamic braking allowable usage will be set to 3% to detect when the load brake has excess wear and needs to be serviced.
- If the status of the fault was during RUN and the hoist is operating in closed loop AA121 = 10 then the dynamic braking allowable usage ratio may not be set properly, contact Detroit Hoist for assistance in correcting this issue.
- Contact Detroit Hoist for further assistance.



## TROUBLESHOOTING E007 FAULT

WHAT IS AN E007 FAULT – An E007 fault is a dc-bus over-voltage fault.

- Check the dynamic braking resistor circuit. Check that the resistor is connected to the correct terminals RB & P+. Check if the resistor is open using a multimeter.
- If the deceleration time is too short, try increasing the deceleration time.
- If the resistor ohm value might be the incorrect value and a new resistor with a lower ohm value may be required.
- If a regenerative unit is used, then check that the regenerative unit is online and functioning correctly and not in a fault status. Also check if the regenerative is going offline due to power imbalance or noise.
- If the status of the fault was while at STOP then this typically points to the input power spiking. Check the incoming power for spikes or if large machinery is starting up causing sags and spikes. If this is the case, then try adding a line reactor in front of the main power of the crane.
- Contact Detroit Hoist for further assistance.

## TROUBLESHOOTING E014 / E030 FAULT

WHAT IS AN E014 and E030 FAULT – An E014 and E030 fault are both referenced as ground faults.

- Check the output conductors for short to ground. Try disconnecting the motor leads from the VFD side and see if the fault no longer persists.
- Test the motor with a megger for insulation break down or for corona discharge insulation damage.
- Check the motor for high moisture contamination.
- Contact Detroit Hoist for further assistance.

## TROUBLESHOOTING E016 FAULT

WHAT IS AN E016 FAULT – An E016 fault is an instantaneous power failure fault. When the power is removed and restored within a very short period the VFD will detect that as an instantaneous power failure and will fault to protect the VFD and motor.

- Check the incoming power for sags or if large machinery is starting up causing sags and spikes. If this is the case, then try adding a line reactor in front of the main power of the crane.
- Check if the mainline or power supply disconnect / switch / contactor is functioning correctly.
- If the problem is based on sags, then changing the control circuit power supply from the incoming AC lines to tapping the dc-bus may reduce the chance of an E016 fault, see image below modified red circuit as reference to changing the circuit.
- Contact Detroit Hoist for further assistance.

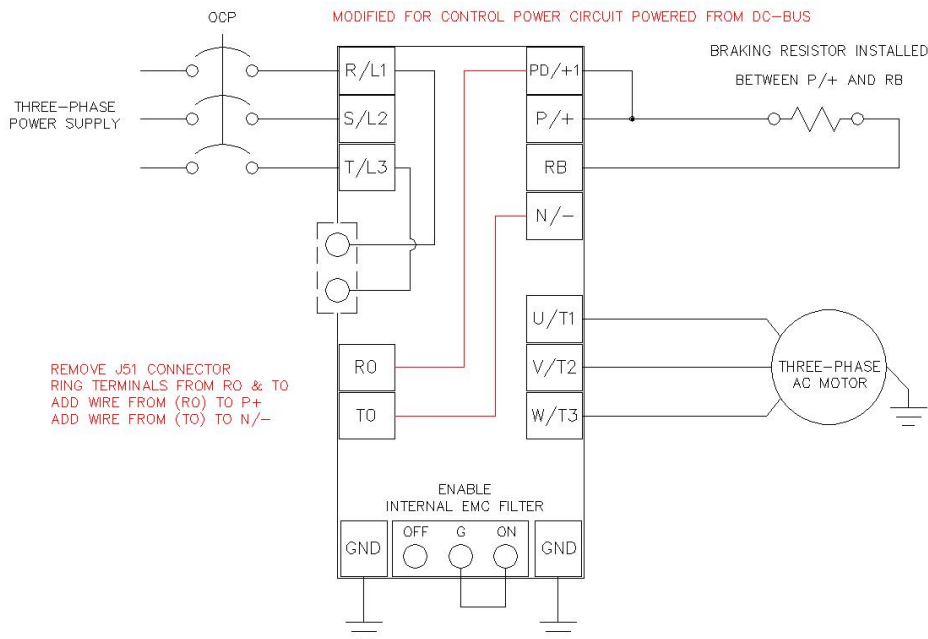
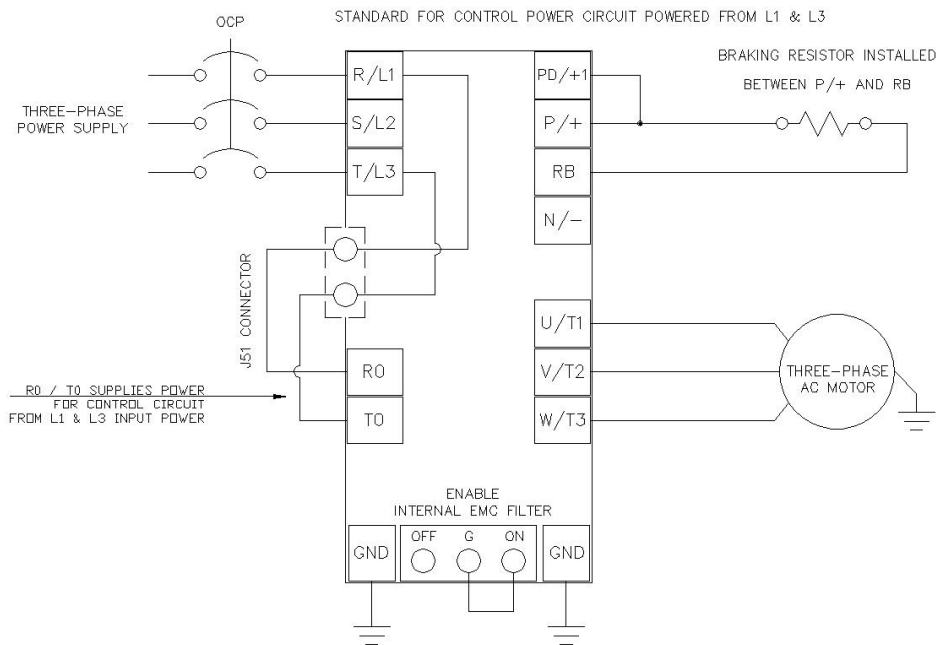

## TROUBLESHOOTING BLANK SCREEN / DISPLAY

If the VFD's screen / display is blank, it usually means the internal 24v power supply is shorted or damaged. In most cases if a connected circuit is causing the short, disconnecting that circuit will restore 24v power to the screen / display.

- Check for power on the VFD's L1 and L3 input power terminals.
- Disconnect the encoder wires from the VFD's main body control circuit terminals A, B, COM, CM1.
- Disconnect all wires from the VFD's main body control circuit terminals related to 24v, (COM, P24, P-, P+, CM2)
- Contact Detroit Hoist for further assistance.

## TEMPORARILY SWITCHING FROM CLOSED LOOP TO OPEN LOOP

In the case of an encoder failure, it might be required to switch from closed loop to open loop in order to lower a load.

**DO NOT** continue to operate the hoist in open loop mode unless for troubleshooting purposes without a load suspended.

Operating a closed loop hoist in open loop mode other than for the purpose of troubleshooting without a load suspended or lowering a load is **HIGHLY DISCOURAGED** since all safety features will be disabled. **If an E51 fault was occurring, DO NOT switch to open loop mode with a load suspended or the load may fall, use other means to remove suspended load if possible.**

To switch from closed loop to open loop change parameter AA121 = 08 SLV for high torque output.

No other parameters are required to be changed. All safety functions will be bypassed automatically, and the encoder limit functions will be ignored. The brake release circuit will be switched over to the open loop brake control using brake release and set frequencies.

Function	Parameters	Value
VFD Control Mode	AA121	10: Closed Loop Vector
		08: Open Loop SLV
<b>IMPORTANT!</b> – If an E51 fault was occurring, <u>DO NOT</u> switch to open loop mode with a load suspended or the load may fall, use other means to remove suspended load.		

## FAULT / ERROR CODES DESCRIPTION

Fault / Error Code	Description
E001	Over-current error
E005 / E039	Electronic thermal overload error (motor current > bC110)
E006	Dynamic braking resistor over used error
E007	DC-Bus over-voltage error
E008 / E011	Memory error / CPU error
E009	Undervoltage error
E010	Built-in current detector error
E012	External trip error (digital input configured for Ext)
E013	USP error This error occurs if an operation command has been input to the inverter when the power supply is turned ON. Operation command detection is carried out for 1 second after the power supply is turned ON. (When USP function is selected.)
E014	Ground fault error
E015	Incoming voltage error (input power supply is too high)
E016	Instantaneous power failure error
E019	Temperature detector error
E020	Temperature error Cooling fan rotation speed reduction error
E021	Temperature error
E024	Input open-phase error When [bb-65] input phase loss selection is set to 01, and when a missing phase is detected in input line, the inverter turns OFF its output.
E030	IGBT error (ground fault to motor or on output of VFD)
E034	Output open-phase error When the output phase loss selection [bb-66] is set to 01, when a loose connection or disconnection of output line, disconnection inside the motor, etc. is detected, the inverter turns OFF its output. Detection of phase loss state is executed in the section between 5Hz to 100Hz.
E035	Thermistor error
E036	Brake error
E038	Low-speed range overload error
E039	Electronic thermal overload error (motor current > bC110)
E040	Operator keypad communication error
E041	RS485 / EZCOM communication error When CF-05 = 0 or 1
E042	RTC error
E043 / E044 / E045	Internal Program illegal instruction error

E050	Brake Slip Detection error
E051	Motor Torque Proving error
E052	Speed Deviation error
E053	Over-Torque error
E054	Shock-Load Detected
E060 – E069	Option card slot 1 connection error
E070 – E079	Option card slot 2 connection error
E080 – E089	Option card slot 3 connection error
E090 – E096	STO path error / FS option error
E100	Encoder disconnection error when using P1-FB option card
E104	Position control range error The encoder position data exceeded (268435455   -268435455) pulses
E105	Speed deviation error
E106	Position deviation error When using the hook position syncing the follower VFD's position deviated over the value in parameter bb-86 for the amount of time in parameter bb-87
E107	Over-speed error
E112	P1-FB option card connection error

## VIEW FAULT HISTORY

To view the fault history, use the step chart below.

Step	Instruction
1	Power on the VFD.
2	Press the left arrow button 2 times to view the fault history list.
3	Use the up and down arrow buttons to scroll through the fault history list and use the center dot button to select the fault and view information as in date / time / fault / status / output current / dc-buss / ext.
4	Press the right arrow button 2 times to return to the main view or keep pressing it until you reach the view you desire.

### Check Error History!

#### Trip History "Total Count Monitor"



- I want to check trip history.



- To display time in trip history, you need to configure clock settings.
- To use the clock function, you need an optional battery that is separately sold.



- On the screen that is displayed upon power-on, using the right and left (◀▶) keys, navigate to "H06".



- The trip history screen "Total monitor" shows details of the errors that have occurred and the total number of times trip occurred.
- For details of errors, see "Chapter 18 Tips/FAQ/Troubleshooting".

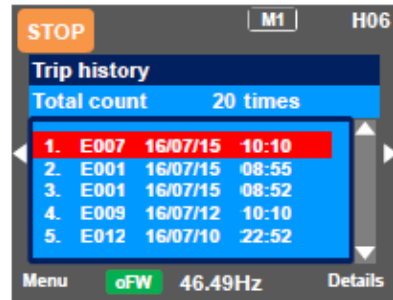

Set-up procedure	Action
<p>Trip history Total count 20 times</p> <p>6. E001 16/05/10 19:22 7. E001 16/04/21 20:59 8. E007 16/03/30 23:55 9. E001 15/12/25 01:34 10. E005 15/12/24 22:10</p>	5.1.1 Using the up and down (▲▼) keys, select history information you want to check. To 5.1.2
<p>Detailed trip history (No. 10) Motor overload error</p> <p>E005 15/12/24 22:10 Output Frequency: 0.50Hz Output Current: 49.71A DC voltage: 274.1VDC Status 1: Run</p>	5.1.2 Press the SEL(O) key to show details of the selected history information. To 5.1.3
<p>Detailed trip history (No. 10) Motor overload error</p> <p>Status 3: Speed control Status 4: Overload limit Status 5: — RUN time: 20256 hr ON time: 27248 hr</p>	5.1.3 Using the up and down (▲▼) keys, you can check details. Press the F1(1) key to return to the monitor.

## CLEARING FAULT HISTORY

To clear the fault history, use the step chart below.

Step	Instruction
1	Power on the VFD.
2	Press the #1 button one time to view the menu screen.
3	Use the arrow buttons to highlight "SCROLL MODE" and press the center dot button to enter the "SCROLL MENU".
4	Use the arrow buttons to scroll down to "U:Set-up, PDN" and press the center dot to enter the "U parameter group".
5	Press the #2 button once to change from the 'UA' group to the "Ub" group.
6	Use the arrow buttons to highlight parameter "Ub-01 Initialize Mode" and press the center dot to enter the "Ub-01" parameter.
7	Use the arrow buttons to highlight the value "1 TRIP" and then press the #2 button to save the value. The screen will automatically return to the "Ub" parameter listing.
8	Use the down arrow button to navigate and highlight parameter "Ub-05 Initialize" and press the center dot button to enter the "Ub-05" parameter.
9	Use the arrow button to highlight "1 Initialize" and then press the #2 button to save the value. The VFD will clear the trip history.
8	You can use the #1 button to return to the main screen by pressing it 3 times or just cycle power.

**Q**

- I don't know how to use the operator keypad VOP.
- I don't understand what is shown on the window.

**A**

- The overview of the operator keypad is given below.
- \* The color of the screen image may be different from the actual color.

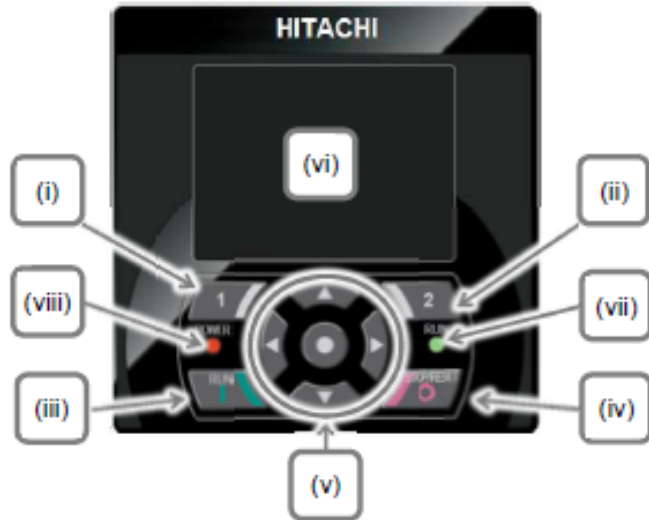

- About display screen (vi)

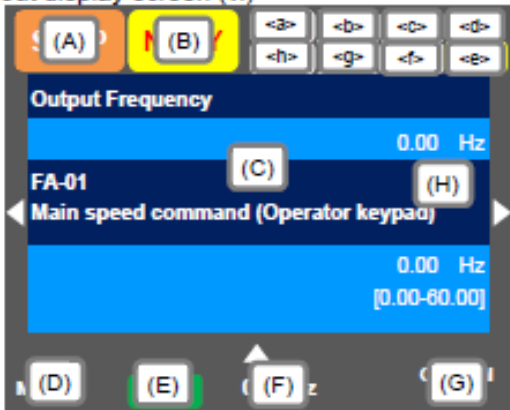

No.	Name	Setting
(i)	F1 key	Displays functions such as navigation to the home screen and cancellation at the bottom left of the screen.
(ii)	F2 key	Displays functions such as data storage at the bottom right of the screen.
(iii)	RUN key	The device runs when this key is enabled.
(iv)	STOP/RESET key	Performs deceleration stop and trip reset.
(v)	Arrow keys & SEL key (center)	Select data on the screen using arrow keys, and confirm by pressing the O key in the center.
(vi)	Display screen	Displays parameters and data.
(vii)	RUN lamp	Turns on when an operation command is sent.
(viii)	POWER lamp	Turns on when the operator keypad is ON. Turns on when R0 and T0 on the main circuit or P+ and P- on the terminal block are ON.

No.	Description
(A)	Displays the operation status.
(B)	Displays the warning status.
(C)	Displays data/parameters.
(D)	Displays details of the function assigned to the F1 key.
(E)	Displays the operation of RUN key on the operator keypad.
(F)	Displays frequency command, torque command, inverter name, clock, etc. The function to be displayed in this section can be selected using the F2 key (option) on the main screen.
(G)	Displays details of the function assigned to the F2 key.
(H)	When soft-lock function is enabled, the [LKS] mark is displayed.

No.	Name	Description
<a>	Power status	Displays the type of input power supply.
<b>	SET function	Displays which of the first setting or second setting is selected for SET terminal function.
<c>	Parameter	Displays the status of display restriction mode.
<d>	Screen No.	Displays the screen number.
<e>	STO function	Displays the STO command.
<f>	Control mode	Displays the command control mode.
<g>	EzSQ	Displays the program operation of EzSQ.
<h>	Special status	Displays the operation of special function.



- Sections of display screen on the operator keypad

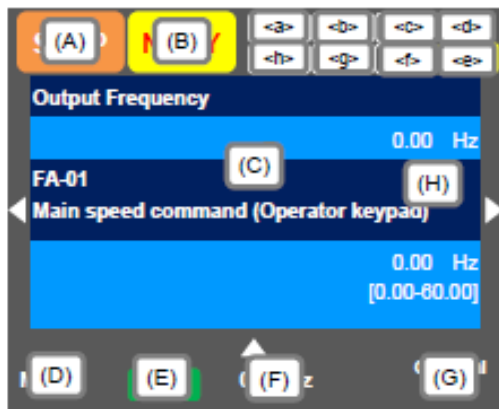

Display (A) Main Operation status display

No.	Indication	Description
A1		Displayed during normal rotation operation. There is a parameter that cannot be changed during operation.
A2		Displayed during reverse rotation operation. There is a parameter that cannot be changed during operation.
A3		Output is in process by 0Hz command. This is also displayed by DB, FOC, and SON functions. There is a parameter that cannot be changed during operation.
A4		Displayed during trip after the occurrence of error. For errors that cannot be canceled, perform reset operation to cancel. -> 18.3.1 Checking the Trip Information
A5		Displayed when setting inconsistency occurs. Resolve the inconsistency. -> 18.5.2 Checking the Setting Inconsistency
A6		This is displayed when the device is forcibly stopped by a function although an operation command is issued. <ul style="list-style-type: none"> <li>The operation command is issued with frequency command at 0Hz.</li> <li>When the operation command is issued from a source other than the operator keypad, the device is stopped by the STOP key on the operator keypad.</li> <li>When the operation command is issued from a source other than the operator keypad, the device is stopped by the breaking terminal function [RS], [FRS], etc.</li> <li>The device is stopped by the instantaneous power failure non-stop function.</li> </ul> At this time, the RUN lamp blinks.
A7		The operation is suspended due to lack of operation command. <ul style="list-style-type: none"> <li>If the operation command is issued from than the operator keypad, the operation is stopped when the breaking function is enabled.</li> </ul>

(Tips)

- A6: When set to STOP (in red)
- > If Display(F): Frequency command is set to 0.00Hz, the frequency command is 0Hz. Check if the frequency command is issued.
- > For example, while the device is running with the [FW] terminal, if it is stopped by the stop key, operation restarts when the [FW] terminal is turned on after turned off once.

Display (B) Warning status display

No.	Indication	Description
B1		This is displayed by the following functions. <ul style="list-style-type: none"> <li>Under overload limit</li> <li>Under torque limit</li> <li>Under overcurrent suppression</li> <li>Under overvoltage suppression</li> <li>Under upper/lower limit operation</li> <li>Under jump frequency operation</li> <li>Under minimum frequency limit</li> </ul>
B2		This is displayed by the following functions. <ul style="list-style-type: none"> <li>Overload advance notice</li> <li>Motor thermal advance notice</li> <li>Inverter thermal advance notice</li> <li>Motor heating advance notice</li> </ul>
B3		Displayed during retry standby or restart standby.
B4		Operation is not started even if the operation command is issued. <ul style="list-style-type: none"> <li>Under insufficient voltage of the main power</li> <li>Under operation only by the 24V power supply</li> <li>Under reset operation</li> <li>Off when the [REN] terminal function is enabled</li> </ul>
B5		Displayed upon the fan life advance notice.
B6		Displayed upon the capacitor life advance notice on the circuit board.
B7		Displayed upon the fan life advance notice and capacitor life advance notice on the circuit board.
B8	(None)	A status other than above

(Tips)

- B1:LIM and B2:ALT are displayed when current or internal voltage is rising. If an error occurs, load or other element needs to be reconsidered.
- If it is determined that the life of cooling fan or capacitor on the circuit board is ending, the indication above is displayed.

Display (E) Display of RUN key function on the operator keypad

No.	Indication	Description
E1		Normal rotation by the RUN key on the operator keypad.
E2		Reverse rotation by the RUN key on the operator keypad.
E3	>FW icon"/>	The RUN key is enabled by the [F-OP] terminal or VOP function. (Normal rotation)
E4	>RV icon"/>	The RUN key is enabled by the [F-OP] terminal or VOP function. (Reverse rotation)
E5	(None)	The command other than the RUN key is selected.

(Tips)

- This section is displayed when the RUN key on the operator keypad is enabled.
- To run the device from the operator keypad while this item is not displayed, check [AA111] first.

- Sections of display screen on the operator keypad

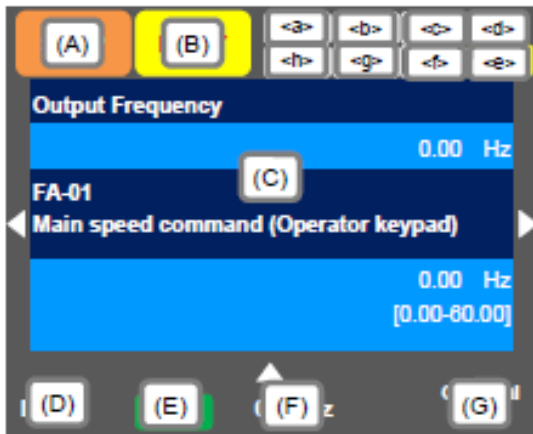

### <a> Power status display

No.	Indication	Description
a1	(None)	There is input to the main power supply/control power supply.
a2	CTRL	There is input to the control power supply.
a3	24V	The device runs with 24V input to P+/P-.

(Tips)

- Indicates the status of power input. When CTRL or 24V is displayed, main power is not input, which makes operation impossible. Check the power supply.

### <b> Display of SET function operation status

No.	Indication	Description
b1	M1	The [SET] terminal is not selected or the [SET] terminal is selected but the function is disabled. (common setting and first setting are enabled)
b2	M2	The [SET] terminal is selected and the function is enabled. (common setting and second setting are enabled)

- If the [SET] terminal is not used, M1 is displayed. If the center of parameter is "-" (common setting such as [AC-01]) or "1" (first setting such as [AA111]), the setting is enabled, and "2" (second setting such as [AA211]) is ignored.

### <c> Selection of parameter display

No.	Indication	Description
c1	(None)	All-parameter display mode.
c2	UTL	Individual-function display mode.
c3	USR	User-setting display mode.
c4	CMP	Data-comparison display mode.
c5	MON	Monitor display mode.

(Tips)

- This section is displayed when the display limit function is working. If there is a hidden parameter, change the setting in [UA-10].

### <d> Display of monitor screen No.

(Tips)

- Displays the screen number of each monitor. When making inquiries, please tell us the number of monitor displayed on your screen. The list of monitor screen numbers is shown in the next page.

### <e> STO function display

(Tips)

- If the function is displayed, it means the current is shut off.
- For details of the STO function display, please contact us.

### <f> Display of control command mode

No.	Indication	Description
f1	(None)	The speed control mode.
f2	TRQ	The torque control mode.
f3	POS	The position control mode.

(Tips)

- Indicates the mode of control operation.

### <g> Display of EzSQ operation mode

No.	Indication	Description
g1	(None)	EzSQ is not selected.
g2	Ez_S	The EzSQ program is stopped.
g3	Ez_R	The EzSQ program is working.

(Tips)

- You can check whether the EzSQ function is working.

### <h> Display of special function status

No.	Indication	Description
h1	(None)	The device is not in the special status.
h2	AUT	The device is auto-tuning.
h3	SIM	The device is in the simulation mode.

(Tips)

- If the function is displayed, it means that the device is in the special state.

## Transition of Operator Keypad Screen

- Types of main monitor screen



- Menu screen

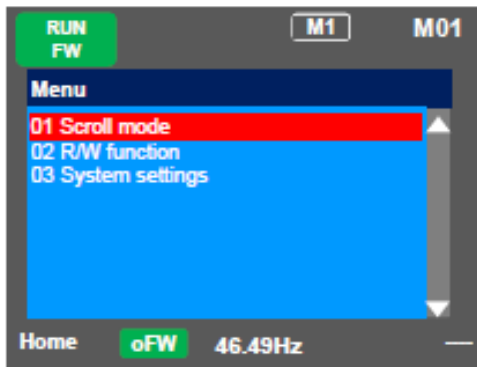

- Home screen option

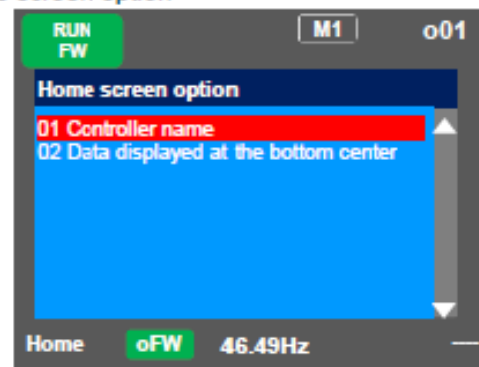

- You can switch between the main screen and menu screen using the F1(1) key.



- You can navigate to the home screen option from the main screen by using the F2(2) key. To return to the home screen, press F1(1) key.

## Checking the List and Configuring "Scroll Mode"



- I want to first configure settings to rotate the motor.
- To configure inverter settings, I want to change parameters.
- I want to check parameter settings all at once.



- Press F1 (Menu) key on the screen that is displayed upon power-on (Multi-monitor in the example below) to move to the system settings screen (M01).

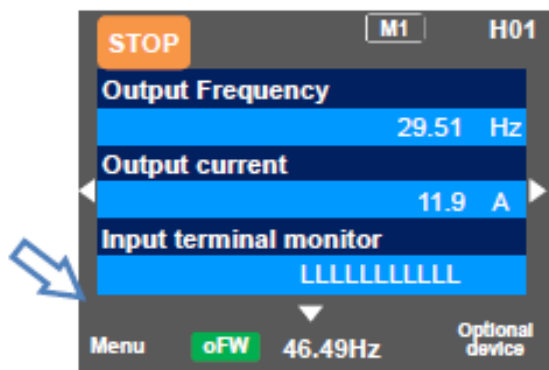

- When configuring basic settings of motor, base frequency, rated voltage of motor, input and output of terminals, as well as when configuring individual functions, change parameters in the scroll mode.
- You can check list of setting data of parameters in the scroll mode, therefore, it is also useful when checking the settings.
- In the system settings, if the scroll screen is set to the initial screen, dA-01, dA-02, and dA-03 of the d: Monitor are initially displayed.

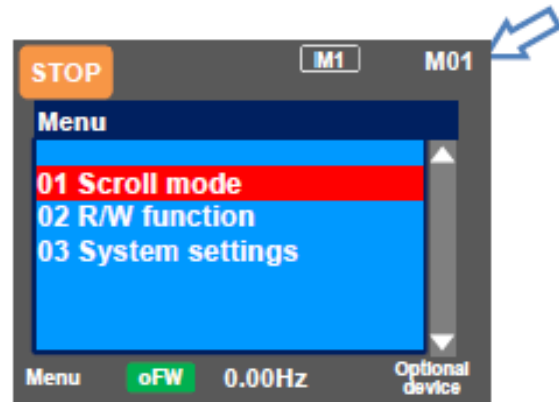

Scroll menu - Parameter selection screen

Set-up procedure	Action
	<p>3.1 Choose the scroll mode on the system settings screen (M01) and press the SEL(O) key to show the scroll menu (L01). To 3.2.</p>
	<p>3.2 Choose a group you want to browse using the up and down (<math>\Delta</math>/<math>\nabla</math>) keys, and then press the SEL(O) key to move to the parameter list display. For example, select "H: Motor control". Example: In the example shown below, the Hb group, which is a basic parameter of induction motor, is checked, and a parameter is changed. To 3.3.</p>

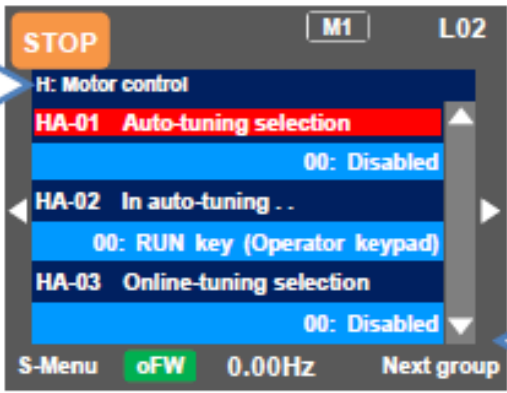
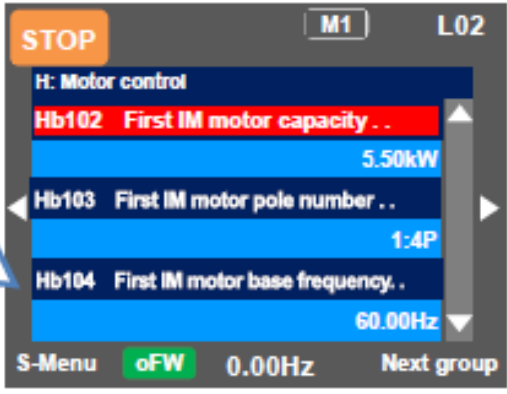
Set-up procedure	Action
	<p>3.3 Parameters of "H: Motor control" are displayed. Using the up and down (<math>\Delta \nabla</math>) keys, you can check parameters. Pressing the F2(2) key jumps to the top [Hb102] of the next group of [HA].</p> <p>(Tips) You can jump to the top parameter of the sub-group in the group ([HA], [Hb], etc. in the case of group H) using the F2(2) key (transition is performed in one direction).</p> <p>Example of group H: ...-&gt;HA-&gt;Hb-&gt;HC-&gt;Hd-&gt;HA-&gt;...</p>
	<p>3.4 Using the up and down (<math>\Delta \nabla</math>) keys, you can check parameters. Choose the parameter to change, and then press the SEL(O) key.</p> <p>Example 1) [Hb103] The parameter to change the first IM motor pole number. To 3.5.</p> <p>Example 2) [Hb104] The parameter to change the first IM motor base frequency. To 3.6.</p>

Example 1) Change [Hb103] First IM motor pole number

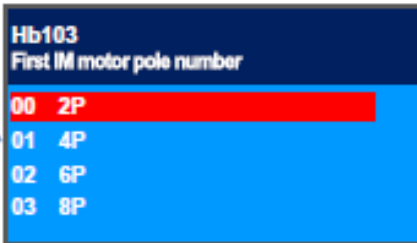
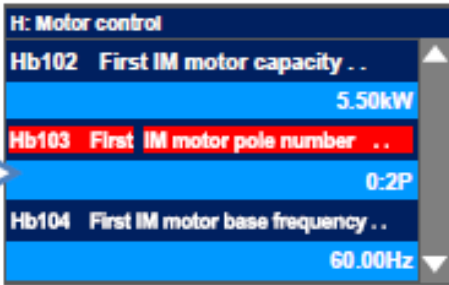
Set-up procedure	Action
	<p>3.5 If the number of motor poles is 2, using the up and down (<math>\Delta \nabla</math>) keys, adjust it to "00 2P", and then press the F2(Save) key.</p> <p>(Tips) Data is saved when the F2(2) key is pressed. It is still saved even after the device is turned off. When configuring an item, the entire screen changes to the screen for setting the item. When not saving the setting after changing it, press the F1(Back) key. The screen returns to the parameter list display.</p>
	<p>3.6 To confirm if the data is correctly changed, check the lower section of the parameter display. Press the F1(1) key three times to return to the monitor.</p>

Example2) Change [Hb104] First IM motor base frequency.

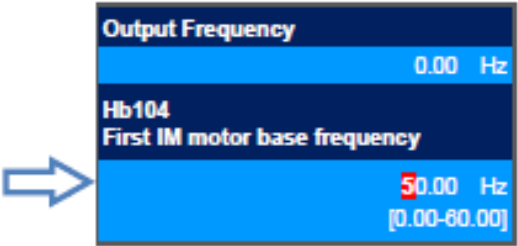
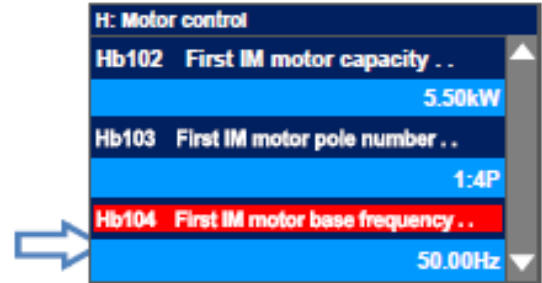
Set-up procedure	Action
	<p>3.8 You can change the right-most digit of data area. Change the value using the arrow (<math>\Delta</math><math>\nabla</math><math>\leftarrow</math><math>\rightarrow</math>) keys, and then press the F2(2) key. To 3.9.</p> <p>(Tips) In the figure on the right, base frequency is changed to 50.00Hz. Data is saved when the F2(2) key is pressed. It is still saved even after the device is turned off. You can make adjustments while performing monitoring. The monitor on the upper area shows the parameter selected in the Big monitor.</p>
	<p>3.6 To confirm if the data is correctly changed, check the lower section of the parameter display. Press the F1(1) key three times to return to the monitor.</p>



- In the scroll mode screen (L02), (i) you can jump to the parameter at the top of each group by using the right and left (◀▶) keys or (ii) jump to the parameter at the top of the sub-group (AA, Ab, etc.) of the group by using F2(Next group) key.

- (i) You can jump to the top parameter of each group by using the right and left (◀▶) keys.  
(...<->All parameters<->: Monitor<->F: Command monitor/setting<->...<->U: Initial setting, PDN<-> All parameters<->...)
- (ii) You can jump to the top parameter of the sub-group in the group (AA, Ab, etc.) using the F2(Next group) key (transition is performed in one direction (see below)).  
• Example of group A: ...>AA->Ab->AC->...>AJ->AA->...

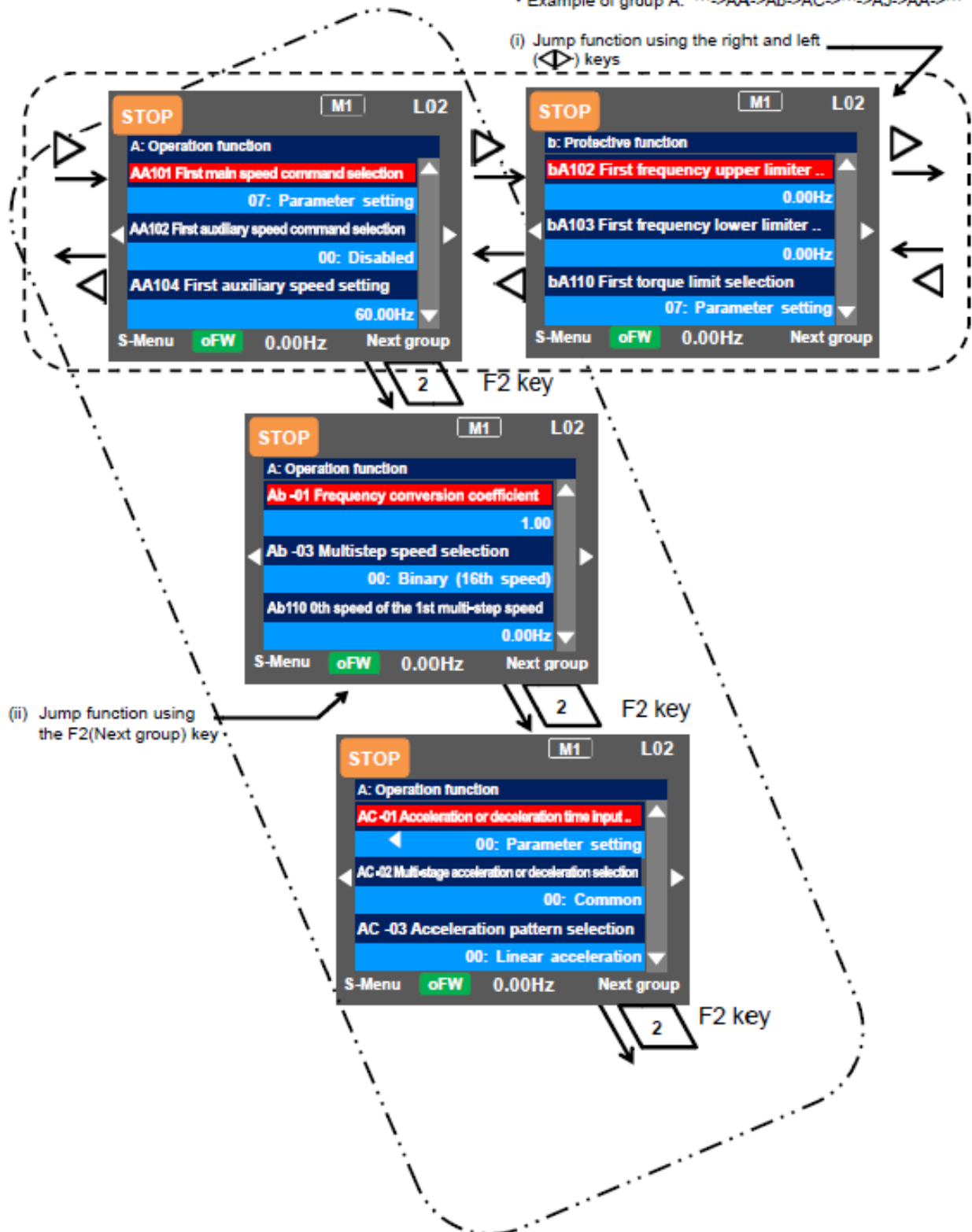

## Monitor Inverter Information

### Three-Line Monitor Screen "Multi-Monitor".



- I want to monitor multiple data at the same time.



- What is displayed on the first line of three-line monitor screen "Multi-monitor" (H01) is the same as that displayed on the upper area of the setting screen "Concurrent monitor" (H03) and the screen with large characters, "Big monitor" (H04).



- On the screen that is displayed upon power-on, using the right and left (◀▶) keys, navigate to "H01".



- In the three-line monitor screen, you can monitor three types of information at the same time. You can change and save the monitored data.

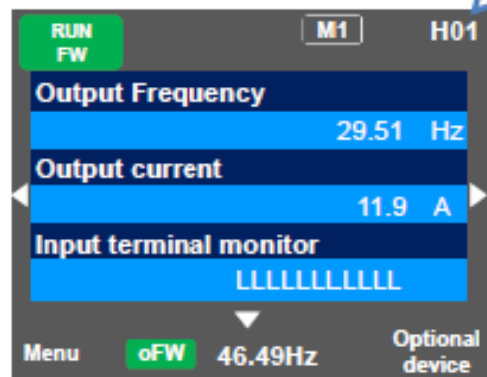

Example) Change the output current monitor to the input power monitor.

Set-up procedure	Action
	4.1.1 Press the SEL(O) key to change the color of the field in upper section. Using the up and down (Δ▽) keys, navigate to the second line. To 4.1.2
	4.1.2 When the SEL(O) key is pressed, the left-most letter of the parameter can be changed. To 4.1.3
	4.1.3 Using the arrow (Δ▽◀▶) keys, change [dA-02] to [dA-30]. To 4.1.4
	4.1.4 Press the SEL(O) key to confirm the monitoring target. Press the F1(1) key to return to the monitor.



## Setting Screen "Concurrent Monitor"



- I want to change the monitor used when changing a parameter while performing monitoring.



- What is displayed on the upper monitor of the setting screen "Concurrent monitor" (H03) is the same as that displayed on the first line of three-line monitor screen "Multi-monitor" (H01) and the screen with large characters, "Big monitor" (H04).



- On the screen that is displayed upon power-on, using the right and left (◀▶) keys, navigate to "H03".



- On the setting screen, you can control parameter data while performing monitoring. To change the selected data, the screen changes to the setting screen that shows options.



Example) Change the output frequency monitor to the PID1 output monitor.

Set-up procedure	Action
	4.2.1 Press the SEL(O) key to change the color of parameter field. Using the up and down (Δ▽) keys to select and navigate to the detail of monitoring. To 4.2.2
	4.2.2 When the SEL(O) key is pressed, the left-most letter of the parameter can be changed. To 4.2.3
	4.2.3 Using the arrow (Δ▽◀▶) keys, change [dA-01] to [db-50]. To 4.2.4
	4.2.4 Press the SEL(O) key to confirm the monitoring target, which is then displayed in the upper section. Press the F1(1) key to return to the monitor. You can also configure parameters using the up and down (Δ▽) keys .

## Monitor with Large Characters "Big Monitor"



- I want to perform monitoring with numeric values displayed in larger size.



- What is monitored on the screen with large characters, "Big monitor" (H04) is the same as the upper monitor of the setting screen "Concurrent monitor" (H03) and the first line of three-line monitor screen "Multi-monitor" (H01).



- On the screen that is displayed upon power-on, using the right and left (◀▶) keys, navigate to "H04".



- In the monitor screen with large characters, you can display a parameter in bigger size.



Example) Change the output frequency monitor to the integrated input power monitor.

Set-up procedure	Action
	4.3.1 When the SEL(O) key is pressed, the left-most letter of the parameter can be changed. To 4.3.2
	4.3.2 Using the arrow (Δ▽◀▶) keys, change [dA-1] to [dA-32]. Press the SEL(O) key to confirm and return to the monitor.

## MANUAL REVISIONS

<i>Manual Version#</i>	<i>Date</i>	<i>What Changed</i>	<i>Firmware Version#</i>
1.0	12/10/2021	<ul style="list-style-type: none"> <li>Initial release</li> </ul>	27
1.1	1/6/2022	<ul style="list-style-type: none"> <li>Fixed typo on Ezcom set-up guide. Added Limit To 1<sup>st</sup> Speed input configuration.</li> </ul>	27
1.2	1/11/2022	<ul style="list-style-type: none"> <li>Added dA-26 to list of monitors.</li> <li>Added note for pulse train position command about inverting the pulse train connection signal if the input encoder signal is inverted.</li> <li>Updated pulse train position command example drawing.</li> <li>Added Manual Revisions to table of contents.</li> </ul>	27
1.3	5/10/2022	<ul style="list-style-type: none"> <li>Firmware V28 feature additions               <ol style="list-style-type: none"> <li>New Adaptive Automatic Auto-Speed.</li> <li>Changed encoder limit approach zone from pulses to rotation counts to allow greater values.</li> </ol> </li> <li>Typo fixes</li> <li>Added reference images for encoder ferrite core magnet.</li> </ul>	28
1.4	10/13/2022	<ul style="list-style-type: none"> <li>Typo fixes</li> <li>Added reference to AE-22 lower limit pulse count store parameter so it can be referenced when manually setting another hoists limit to match identically.</li> <li>Added missing reference to parameter UE-49 for pulse train position command.</li> </ul>	28